

EM35M Series

High Current, Plastic Power Supply Connectors



High-Current



1 Touch Locking



Wide Variation

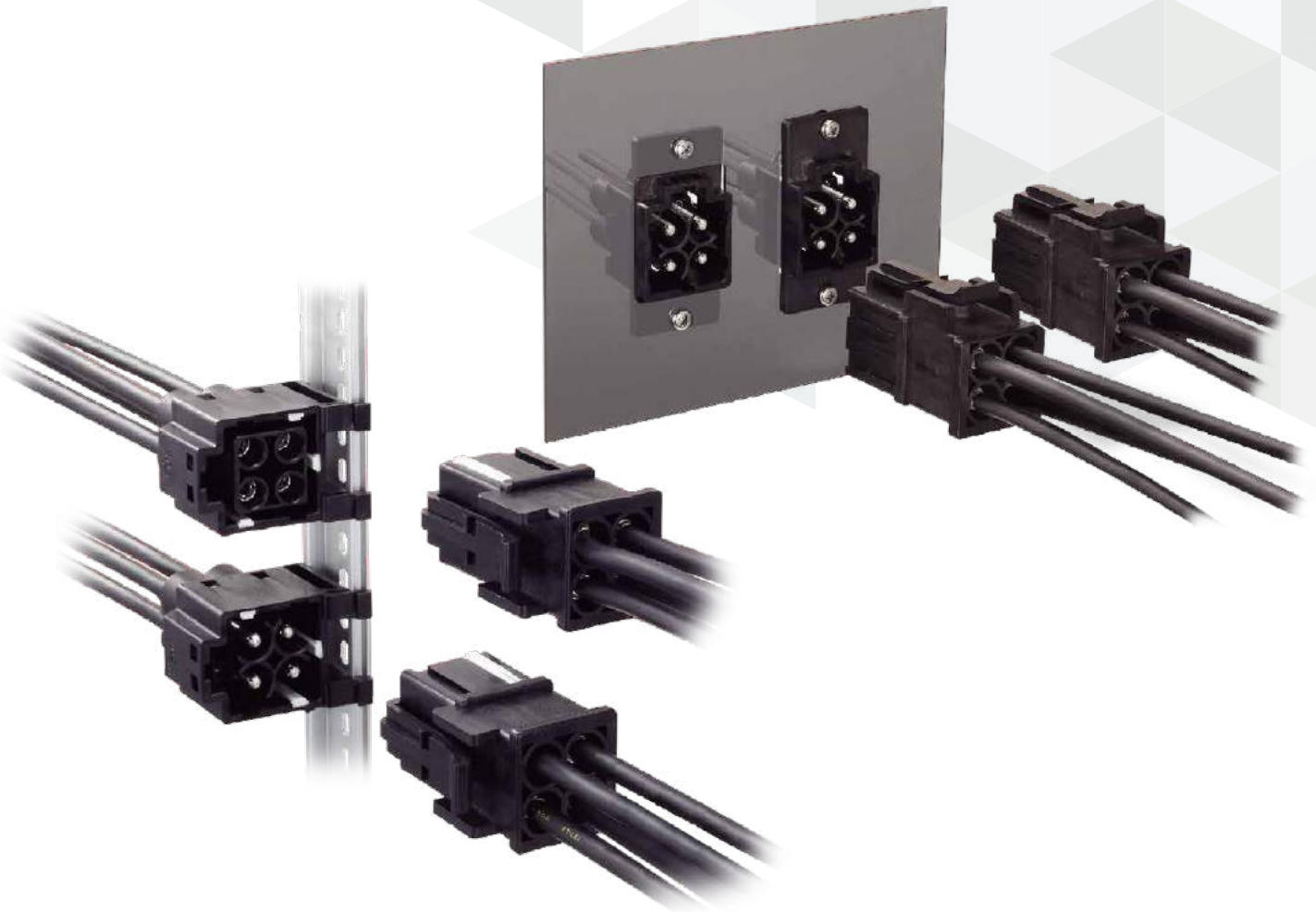

May. 1. 2024 Copyright 2024 HIROSE ELECTRIC CO., LTD. All Rights Reserved.

Features

1. High current capability (three-phase power supply and ground) with 4pos.

- 3 positions each with a rated current of 50A when using 8 AWG or corresponding cable. (70A per contact with 8 AWG wire and ambient temperature 25°C.)
- 3 positions each with a rated current of 30A when using 10 AWG or corresponding cable. (Please refer to the charts below concerning the relation between ambient temperature and working current value.)

2. Easy crimp termination

Crimp contacts are used so anyone can perform uniform termination.

3. Standard tooling available

Contacts can be crimped with a standard tool in accordance with JIS C 9711.

4. Sequential mating

Ground contacts connect before power contacts touch.

5. Snap-in lock is easy to operate

Lock operation can be done by simply snapping the plug to the receptacle.

6. Attachment Styles

- DIN rail mount type
Snap-on attachment to 35mm width DIN rail.
- Panel attachment type
Both front and rear mounting applicable.

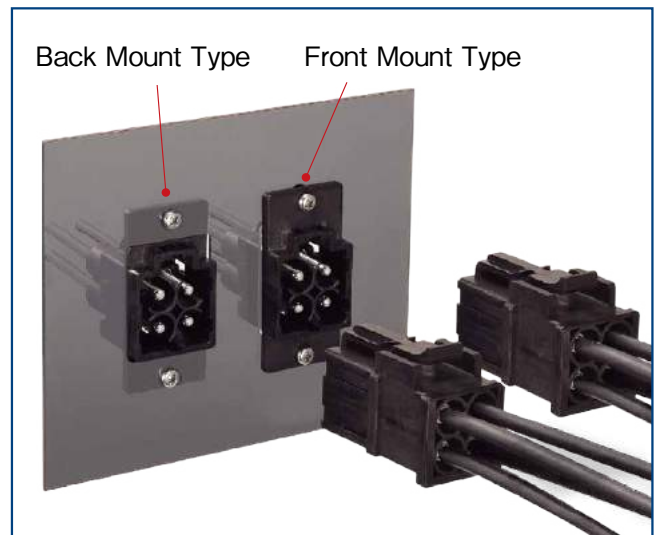
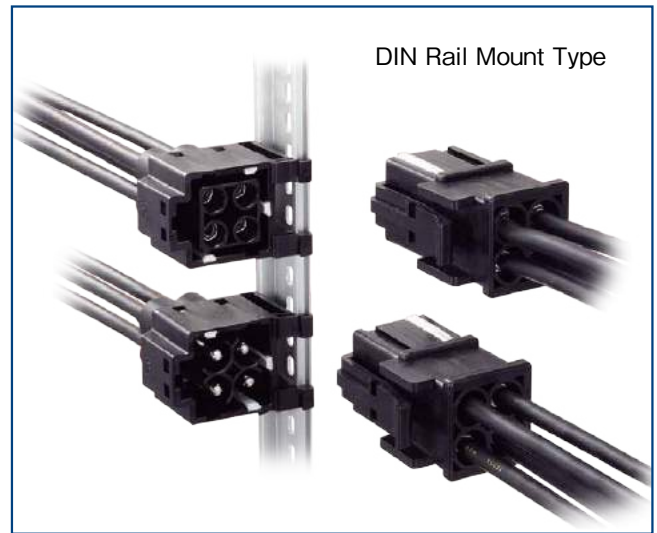

7. Ten keying combinations possible

Guide keys prevent incorrect insertions when multiple connectors are used together at the same time.

8. Meets approved safety standards

TÜV, UL certified.

Product Specifications

Rated Current (Note 1)	10 AWG	8 AWG, Ambient Temperature 25°C	Operating Temperature (Note 2)	-40 to +125°C
	30A	70A	Storage Temperature Range	-10 to +60°C
Rated Voltage	1000V AC/DC			

UL	Rated Current (Note 1)	10 AWG	8 AWG	Operating Temperature (Note 2)	-40 to +125°C
		30A	50A	Storage Temperature Range	-10 to +60°C
	Rated Voltage	500V AC/DC			

TÜV	Rated Current (Note 1)	10 AWG	8 AWG	Operating Temperature (Note 2)	-40 to +125°C
		30A	50A	Storage Temperature Range	-10 to +60°C
	Rated Voltage	500V AC/DC			

Note 1 : The value of rated current varies based on the ambient temperature. It is recommended to use the product within the derating curve zone.

When using a UL or TÜV approved product, please use the product within the specified range as well as the derating curve area.

Note 2 : Includes the temperature rise due to current flow.

Item	Specification	Condition
Contact Resistance	1mΩ Max.	Measured at 1A DC
Insulation Resistance	5000MΩ Min.	Measured at 500V DC
Withstanding Voltage	No flashover and insulation breakdown	4260V AC for 1 min.
Vibration Resistance	No electrical discontinuity of 10 μs or more	10 to 50 to 10Hz/cycle, single amplitude of 0.75mm, five minutes/cycle, three directions, 10 cycles for each direction
Shock Resistance	No electrical discontinuity of 10 μs or more	Acceleration of 490m/s ² , duration of 11ms, three directions, three times for each direction
Mating Durability	Contact resistance : 1mΩ Max.	100 cycles
Temperature Cycle	Insulation resistance : 5000MΩ Min.	-55°C for 30 minutes → room temperature for 2 to 3 minutes → +125°C for 30 minutes → room temperature for 2 to 3 minutes, 5 cycles
Humidity Resistance (Normal Condition)	Insulation resistance : 50MΩ Min. (at high humidity condition) 500MΩ Min. (at dry condition)	Exposed for 96 hours at the temperature of 40°C and a humidity of 90 to 95%

Derating curve

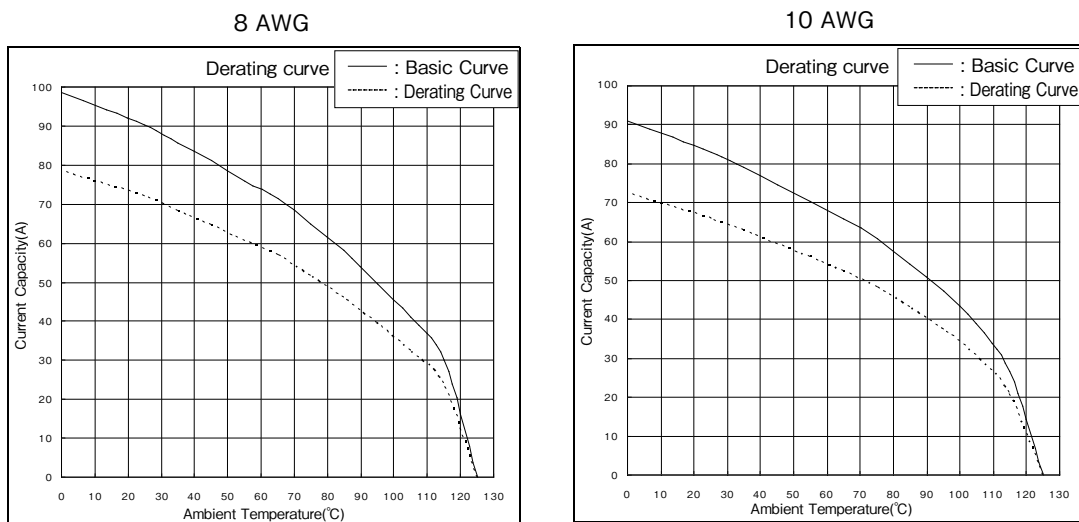

Note 1 : The derating curve is a curve is derived by multiplying the basic curve by the derating factor of 0.8.

Note 2 : The value of rated current varies based on the ambient temperature. It is recommended to use the product within the derating curve zone.
When using a UL or TUV approved product, please use the product within the specified range as well as the derating curve area.

Materials / Finish

Item	Material	Finish	Remarks
Insulation	PBT Resin	-	UL94V-0
Contact	Copper Alloy	Tin Plated (Nickel Under Plating)	-

Product Number Structure

Refer to the chart below when determining the product specifications from the product number.
Please select from the product numbers listed in this catalog when placing orders.

■ Connector

EM 35 M P - 4 S C (##)

① ② ③ ④ ⑤ ⑥ ⑦ ⑧

■ Guide Key

EM - GK (##)

① ④ ⑧

■ Crimp Contact

EM - S C - 1 4 3 (##)

① ⑥ ⑦ ⑨ ⑩ ⑪ ⑧

① Series Name	EM	⑦ Termination Style	C : Crimp
② Shell Size	35	⑧ Specification No.	This position will be used to indicate changes or variations to the product. When needed, there will be a 2 digit number within the parentheses. This number will correspond to specific changes and/or variations with the part.
③ Specialty	M : Mold Type (Plastic Type)		
④ Connector Type	P : Plug R : Receptacle (DIN Rail Mount Type) RA : Receptacle (Panel Attachment Type) GK : Guide Key	⑨ Contact Shape	1 : Loose Piece Contact
⑤ No. of Pos.	4	⑩ Shape Modification	Design variation in the same size contact is indicated with serial numbers starting from 1.
⑥ Contact Gender	S : Female Contact, P : Male Contact	⑪ Plating	3 : Tin Plated

Plug

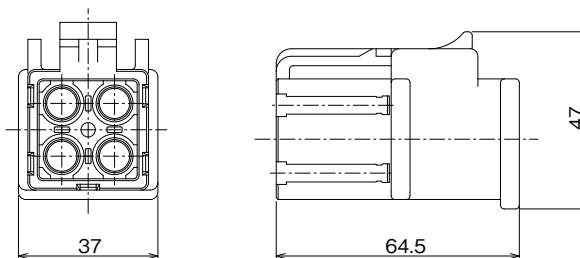

Part No.	HRS No.	Purchase Unit
EM35MP-4SC(81)	CL0138-0020-9-81	1pcs per bag
EM35MP-4PC(81)	CL0138-0021-1-81	

Receptacle (DIN Rail Mount Type)

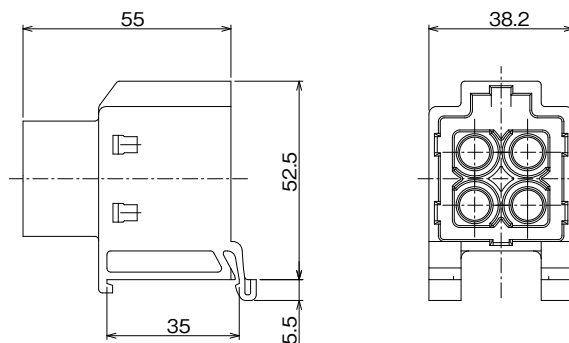

Part No.	HRS No.	Purchase Unit
EM35MR-4PC(81)	CL0138-0022-4-81	1pcs per bag
EM35MR-4SC(81)	CL0138-0023-7-81	

Receptacle (Panel Attachment Type)

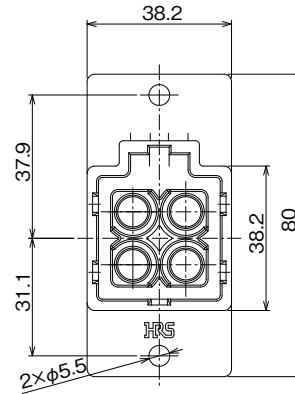
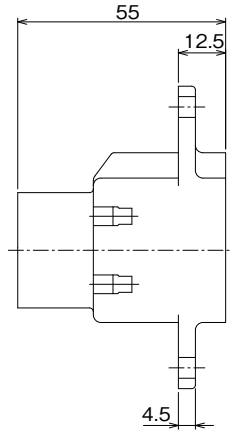

■ Panel Cut Out Dimensions

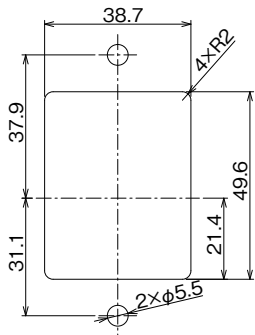

■ Panel Attachment Dimensions

For Front Mount

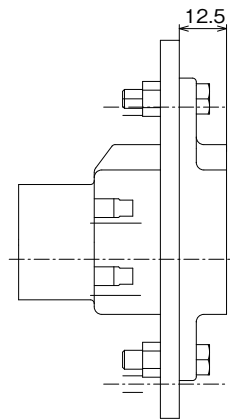

For Back Mount
(Panel thickness : 8mm Max.)

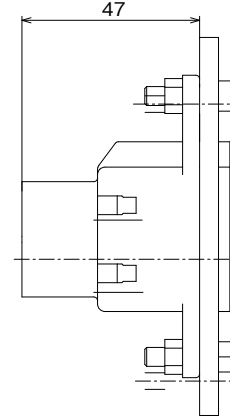

Part No.	HRS No.	Purchase Unit
EM35MRA-4PC(81)	CL0138-0028-0-81	1pcs per bag

Cap

● For Receptacle

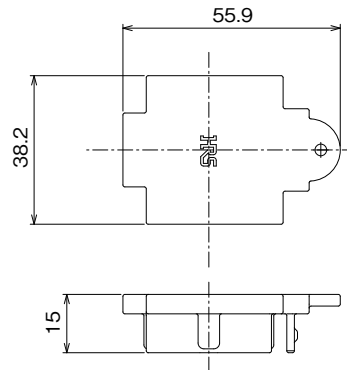

Part No.	HRS No.	Applicable Connector	Purchase Unit
EM35MR-C	CL0138-0029-3-00	EM35MR-4PC	20pcs per bag (Note)
		EM35MR-4SC	
		EM35MRA-4PC	

Note : Orders are accepted in multiples of 20pcs. As an example, if the number of pcs needed for purchase is 100pcs, then the order quantity is 100pcs.

Crimp Contacts

● Male Contacts

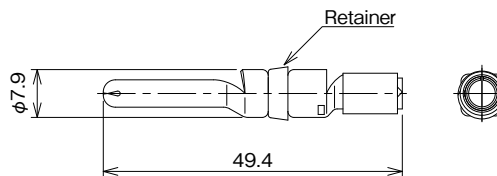

Type	Part No.	HRS No.	Applicable wire	Remarks	Purchase Unit
Loose Piece Contacts	EM-PC-113(01)	CL0138-0011-8-01	(1) Cross sectional area of conductor : 5.26 to 5.57mm ² (corresponding to 10 AWG) (2) Outside diameter of conductor : ϕ 3.1 Max. (3) Outside diameter of jacket : ϕ 8.7 Max. (Wire needs to meet all the specifications listed in 1, 2 and 3.)	Retainer : Black	4pcs per bag (Note)
	EM-PC-133	CL0138-0019-0-00	(1) Cross sectional area of conductor : 8mm ² (2) Outside diameter of conductor : ϕ 3.7 Max. (3) Outside diameter of jacket : ϕ 8.7 Max. (Wire needs to meet all the specifications listed in 1, 2 and 3.)	Retainer : White	
	EM-PC-143(01)	CL0138-0025-2-01	(1) Cross sectional area of conductor : 8.44 to 8.92mm ² (corresponding to 8 AWG) (2) Outside diameter of conductor : ϕ 4.4 Max. (3) Outside diameter of jacket : ϕ 11.5 Max. (Wire needs to meet all the specifications listed in 1, 2 and 3.)	Retainer : Purple	

Note : Orders are accepted based on bag increments. As an example, if the number of pcs needed for purchase is 100pcs, then the order quantity is 25 bags.

● Female Contacts

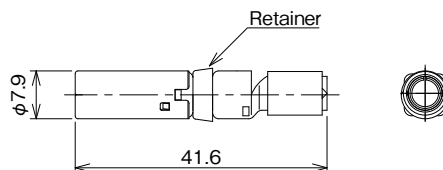

Type	Part No.	HRS No.	Applicable wire	Remarks	Purchase Unit
Loose Piece Contacts	EM-SC-113(01)	CL0138-0010-5-01	(1) Cross sectional area of conductor : 5.26 to 5.57mm ² (corresponding to 10 AWG) (2) Outside diameter of conductor : ϕ 3.1 Max. (3) Outside diameter of jacket : ϕ 8.7 Max. (Wire needs to meet all the specifications listed in 1, 2 and 3.)	Retainer : Black	4pcs per bag (Note)
	EM-SC-133	CL0138-0018-7-00	(1) Cross sectional area of conductor : 8mm ² (2) Outside diameter of conductor : ϕ 3.7 Max. (3) Outside diameter of jacket : ϕ 8.7 Max. (Wire needs to meet all the specifications listed in 1, 2 and 3.)	Retainer : White	
	EM-SC-143(01)	CL0138-0024-0-01	(1) Cross sectional area of conductor : 8.44 to 8.92mm ² (corresponding to 8 AWG) (2) Outside diameter of conductor : ϕ 4.4 Max. (3) Outside diameter of jacket : ϕ 11.5 Max. (Wire needs to meet all the specifications listed in 1, 2 and 3.)	Retainer : Purple	

Note : Orders are accepted based on bag increments. As an example, if the number of pcs needed for purchase is 100pcs, then the order quantity is 25 bags.

Coding Key

Coding keys are used to create keying combinations to prevent incorrect insertion. This is especially useful when multiple parts are being used together. Coding keys need to be installed on both the plug and receptacle when creating specific combinations.

Please contact a Hirose representative for details and proper use of coding keys.

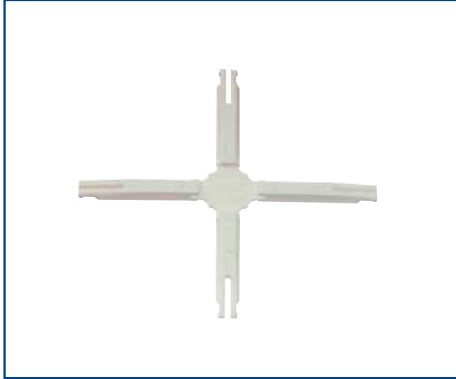

Part No.	HRS No.	Purchase Unit
EM-GK	CL0138-0026-5-00	25pcs per bag (Note)

Note : Each sprue holds 4 coding keys and yields a total of 100 coding keys.

Coding Key Combination Table

Using two coding keys on the plug and three on the receptacle can make up to ten different combinations.

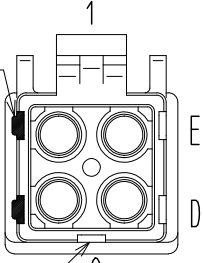
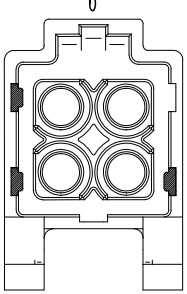
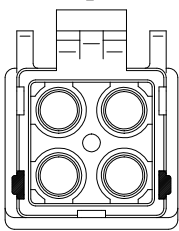
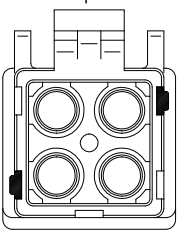
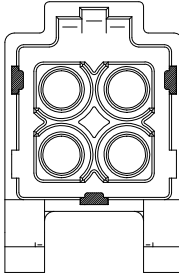
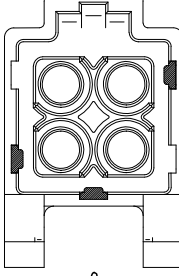
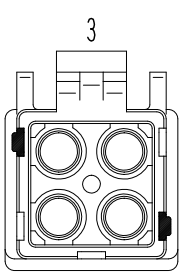
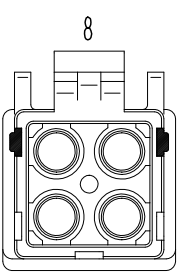
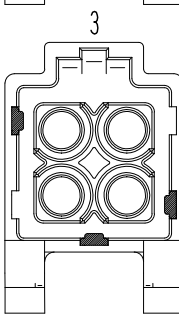
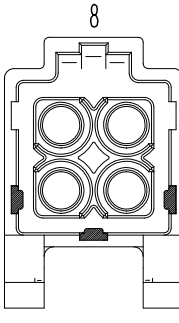
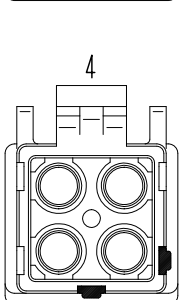
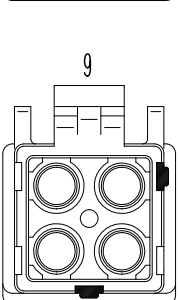
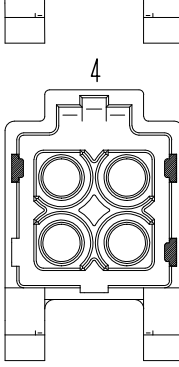
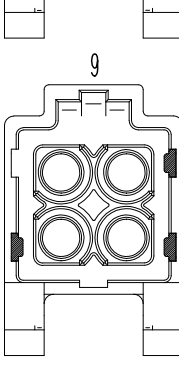
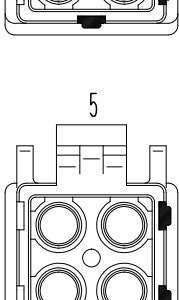
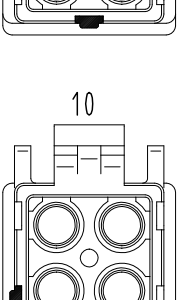
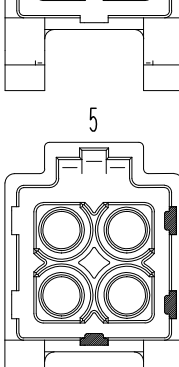
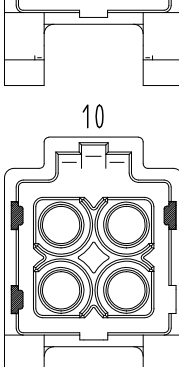
Positioning of Guide Keys on Plug	Positioning of Guide Keys on Receptacle
 <p>Coding Key</p> <p>A</p> <p>B</p> <p>Dovetail Groove</p> <p>C</p>	 <p>Coding Key</p> <p>A</p> <p>B</p> <p>Dovetail Groove</p> <p>C</p>
 	 
 	 
 	 
 	 

Mated Dimensions

Mated Dimensions when Mounted on DIN Rail

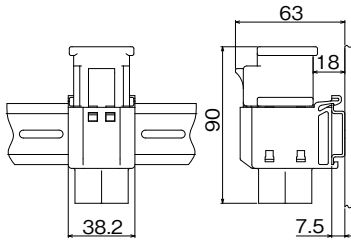

Mated Dimensions when Mounted on Panel

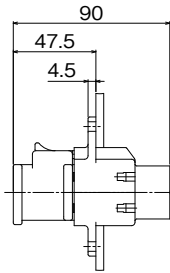

Applicable Tools

Manual Crimping Tool (Example)



Contact Extraction Tool



Type	Part No.	HRS No.	Applicable Contact
Manual Crimping Tool	Note 1	-	EM-PC-113(01), EM-SC-113(01) EM-PC-133, EM-SC-133 EM-PC-143(01), EM-SC-143(01)
Contact Extraction Tool	EM-8-TP	CL0150-0249-3-00	EM-PC-113(01), EM-SC-113(01) EM-PC-133, EM-SC-133 EM-PC-143(01), EM-SC-143(01)

Note 1 : Manual Crimping Tools is a commercially available tool conforming to the JIS C 9711 standard "Termination tools for wire connector of interior wiring".
Only use the recommended tools noted below.

Recommended Crimping Tools

Tool Manufacturer	Part No.
HOZAN TOOL INDUSTRIAL CO., LTD.	P-75
LOBTEX Co., Ltd.	AK15A
NICHIFU TERMINAL INDUSTRIES Co., Ltd.	NH1

Precautions when using the EM Series Connectors

1. Switch off the power before mating or un-mating the connectors.
2. Do not touch the contacts when the connector is energized. Doing so is dangerous and can lead to injury.
3. Please contact a Hirose representative for harness work procedures and instruction manuals.

While taking in consideration

Specifications mentioned in this catalog are reference values.

When considering to order or use this product, please confirm the "Drawing" and "Product Specifications" sheets.

Use an appropriate cable when using the connector in combination with cables.

If considering usage of a non-specified cable, please contact your sales representative.

If assembly process is done by jigs & tools which are not identified by Hirose assurance will not be given.

Please consult with your Hirose sales representative if you are planning to use the product for any of the following applications. (Automotive, medical, public infrastructure, aerospace/defense, etc.)

Hirose will consider the validity of the warranty depending on the conditions.