

APPLICATION NOTE

Accurate Measurements using Shunt Resistors and Current Sense Modules in High-Energy Storage Applications



Introduction

The need to monitor the state of health of lithium-ion cells in battery packs during charging and discharging is a key requirement for Battery Management Systems (BMS) in high energy applications such as Hybrid Electric Vehicles (HEVs) and Battery Electric Vehicles (BEVs). Maintaining performance and safe operation are of paramount importance, as lithium-ion chemistries are prone to degradation and aging issues. A dangerous thermal runaway condition can occur if the ambient temperatures are out of specification or if the batteries are undercharged or overcharged, possibly causing cracks in the carbon and lithium plating.

The three parameters measured by the BMS to determine the state of health of a cell are cell voltage, temperature and current. The traditional solution employed to measure these parameters has been the use of shunt resistors. These passive components feature a relatively high absolute tolerance of 5 %. However, the overall accuracy when combined with a current sense module can be reduced to as low as 0.01 %.

This application note provides helpful BMS design information on the level of accuracy that can be obtained using Bourns® Model CSM2F Series shunt resistors combined with a current sense module designed for this purpose.

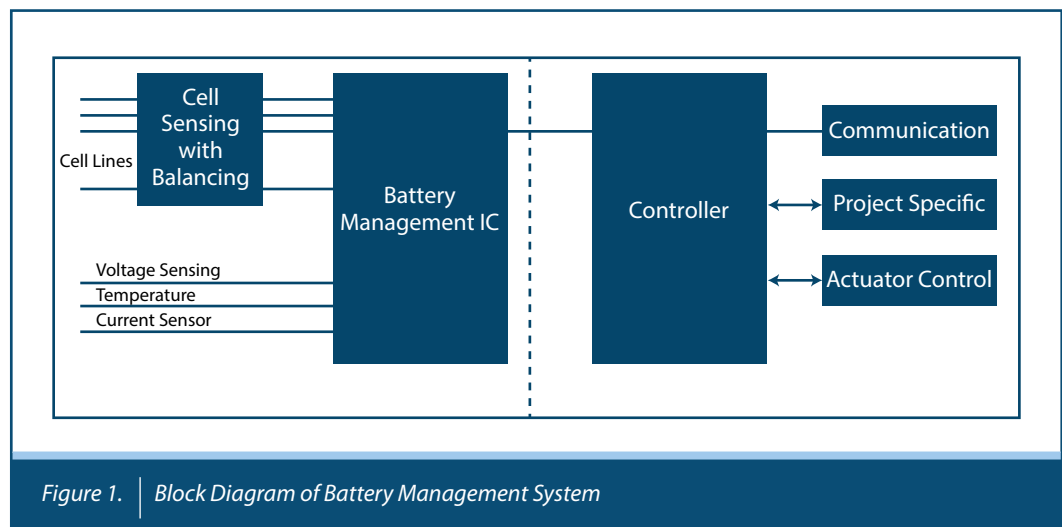

Figure 1. | Block Diagram of Battery Management System





APPLICATION NOTE

Accurate Measurements using Shunt Resistors and Current Sense Modules in High-Energy Storage Applications



Bourns® Shunt Resistors for Battery Current Measurement

Bourns offers three shunt resistor models qualified by Bourns for harsh environment energy storage applications. The following table outlines the key characteristics of these products.

Model	Photo	Power Rating	Resistance Range	Temperature Coefficient (Between Test Points)
CSM2F-6918		36 W	50 to 200 $\mu\Omega \pm 5\%$	50 to 200 ppm/ $^{\circ}\text{C}$
CSM2F-7036		50 W	25 to 100 $\mu\Omega \pm 5\%$	150 and 200 ppm/ $^{\circ}\text{C}$
CSM2F-8515		36 W	50 to 200 $\mu\Omega \pm 5\%$	50 to 200 ppm/ $^{\circ}\text{C}$
CSM2F-8536		50 W	25 to 50 $\mu\Omega \pm 5\%$	150 and 200 ppm/ $^{\circ}\text{C}$

The resistive element in all three models consists of large copper terminals as can be seen in the examples of the CSM Series on the left. Given that the resistivity of copper is $1.72 \times 10^{-8} \Omega\text{m}$ and that the resistance will increase by 0.393 % for every extra degree Celsius in temperature, the overall coefficient of resistance between the two points will be higher than the resistivity of the resistor alloy (max. 50 ppm/ $^{\circ}\text{C}$ or 0.05 %/ $^{\circ}\text{C}$).

If the distance between the two measurement points in copper is 3 mm in total as is the case with CSM2F-8515, the temperature coefficient of resistance, or TCR, will increase from 50 ppm/ $^{\circ}\text{C}$ (TCR of element) to 150 ppm/ $^{\circ}\text{C}$ (TCR of combined element plus copper terminal) in case of 100 $\mu\Omega$ resistance value.

The maximum current these shunts can carry is quite high. The Bourns® Model CSM2F-7036, for example, using Ohm's Law can carry 1000 A, DC/DC at a maximum power 50 watts. A typical battery pack for an HEV is 24 kWh. This is equivalent to 500 ampere hours in a 48 V vehicle. Therefore, the current can be very high, especially during periods of high power such as acceleration when moving or fast charging when stopped.

APPLICATION NOTE

Accurate Measurements using Shunt Resistors and Current Sense Modules in High-Energy Storage Applications



CSS Series
Current Sense Resistors



CSM Series
Current Sense Resistors

Recommendations for Signal Processing

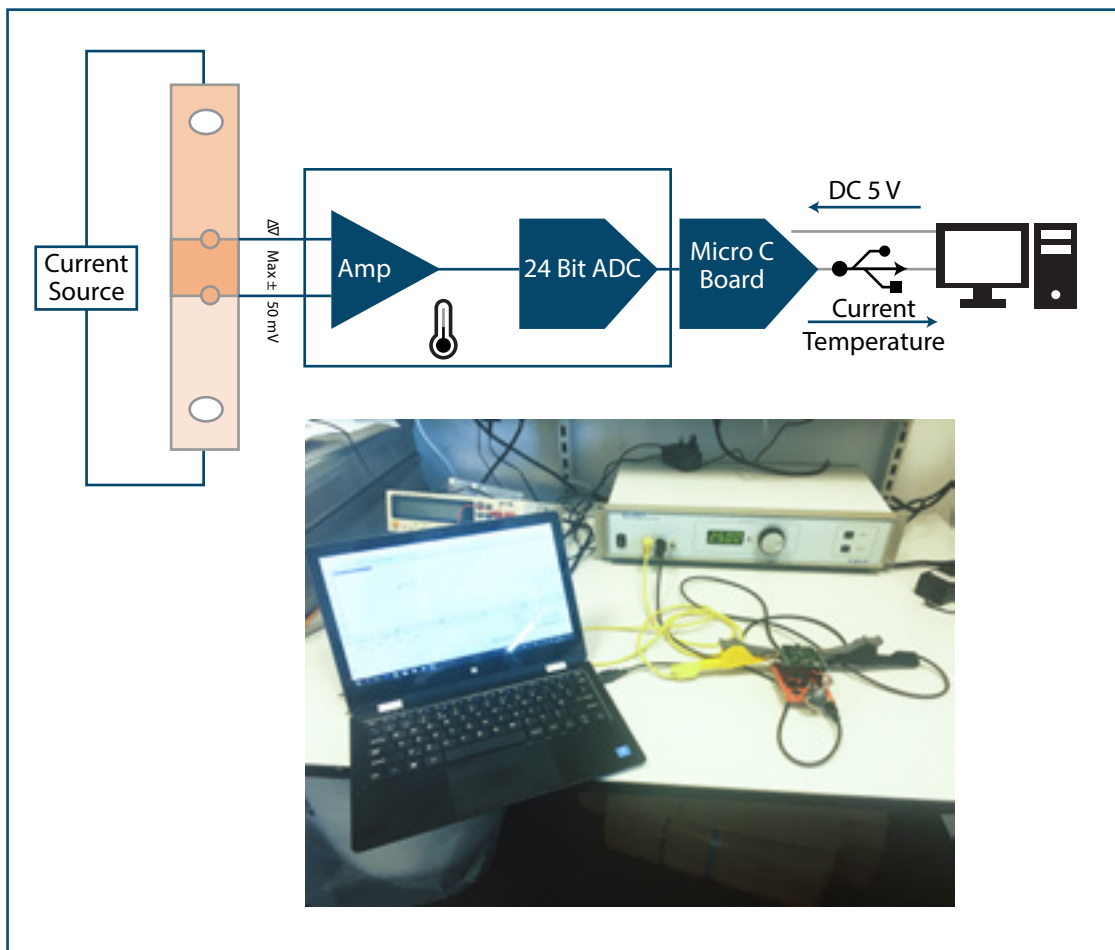

Figure 2. | Block Diagram of Signal Processing Circuit and Photo of Experiment

Bourns developed the typical current source module block diagram, shown in Figure 2, to evaluate the accuracy of a shunt-based current measurement system. The module consists of an Analog Front End (AFE) with a current sense amplifier with analog buffer, 24 bit ADC and SPI interface. There are several high voltage bidirectional current sense amplifiers from Analog Devices such as the [model AD8210 or AD8211](#) which have gains of 20 and common mode voltages of up to 65 V.

To evaluate the shunt, Bourns tested its Model CSM2F-8518 (100 μ ohm nominal resistance) as shown in Figure 2. A single board microcontroller kit is programmed to communicate with the module over an SPI connection. The current for the measurement was generated using a precision current source.

APPLICATION NOTE

Accurate Measurements using Shunt Resistors and Current Sense Modules in High-Energy Storage Applications



Recommendations for Signal Processing (Continued)

The first measurement to be determined is the resistance of the shunt. This is done using the known current from the current source and a precision 4-wire voltmeter. Once the actual resistance of the shunt is measured, then the voltage across the shunt using the current sense module can be compared with the actual resistance value.

The current sense amplifier has a common mode voltage of 80 V maximum allowing for the module to be placed at the high end in 48 V battery systems. The module also contains a surface mount temperature sensor with a PWM output proportional to the ambient temperature. Figure 3 shows the temperature sensor output at room temperature. The amplifier power is supplied by a DC supply of +5 V. The power in this experiment comes from a Low Drop Out (LDO) regulator with the original supply coming from the USB interface. For an isolated 5 V supply a low power micro converter using the ADI LTC8301 (flyback or push-pull) can provide the necessary isolation with the required safety level.

Figure 4 shows the data points collected from the A/D input terminals with an average of 22.44364 mV and peak to peak variation of 0.007 mV over the sampling period.

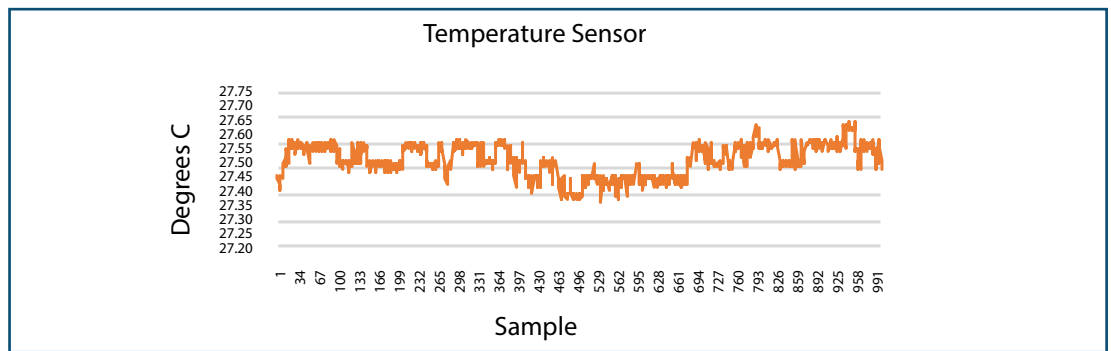

Figure 3. | Data in Degrees Celsius Recorded by the Module

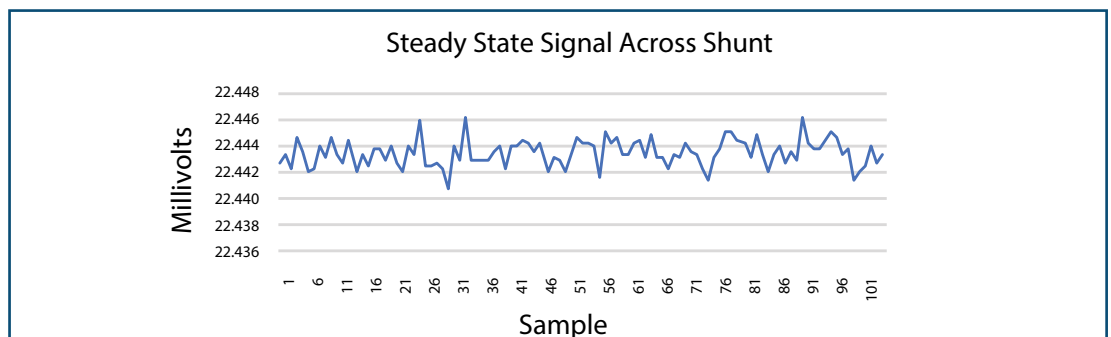

Figure 4. | Data in Millivolts Recorded by the Current Sense Module

APPLICATION NOTE

Accurate Measurements using Shunt Resistors and Current Sense Modules in High-Energy Storage Applications



Determining Measurement Accuracy

The accuracy of the measurements at room temperature can be calculated using the following formula.

$$\text{The accuracy is } \frac{(\text{Expected Voltage}-\text{Actual Measurement})\text{mV} * 100}{\text{Full Range of Op Amp}}$$

The data at several DC currents ranging from 10 mA up to 20 amperes was recorded and the accuracy calculated (shown on the graph in Figure 5). The accuracy tends to degrade once the currents increase beyond 10 amperes and the shunt starts to heat up. The resistance value used to calculate the current will drift as a result, which has a negative impact on the accuracy of the measurements. To further assist designers, Bourns has developed a look-up table that shows the normalized increase or decrease of the resistance with temperature. With this data, the original value used for the resistance can be modified by the factor shown in Figure 6 and correlated with the temperature sensor reading.

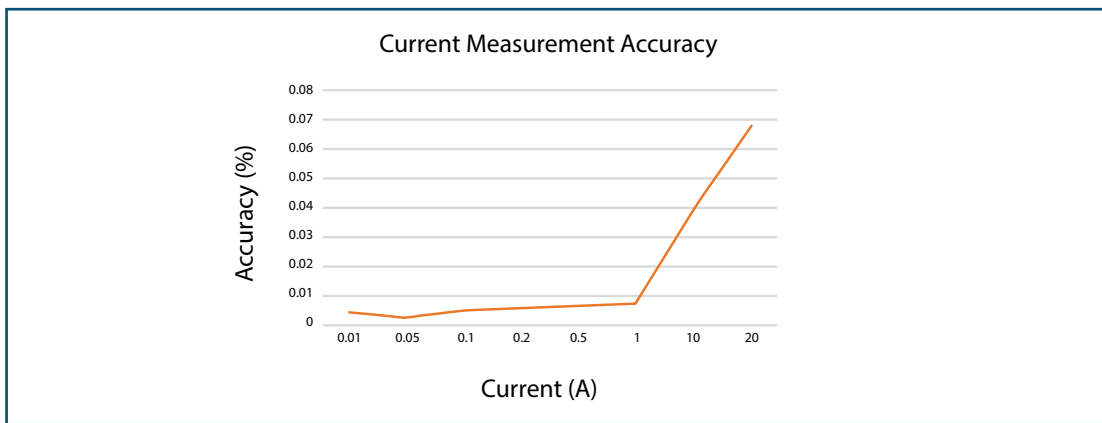

Figure 5. Accuracy of Bourns® Model CSM2F-8518 Shunt with Current Sense Module

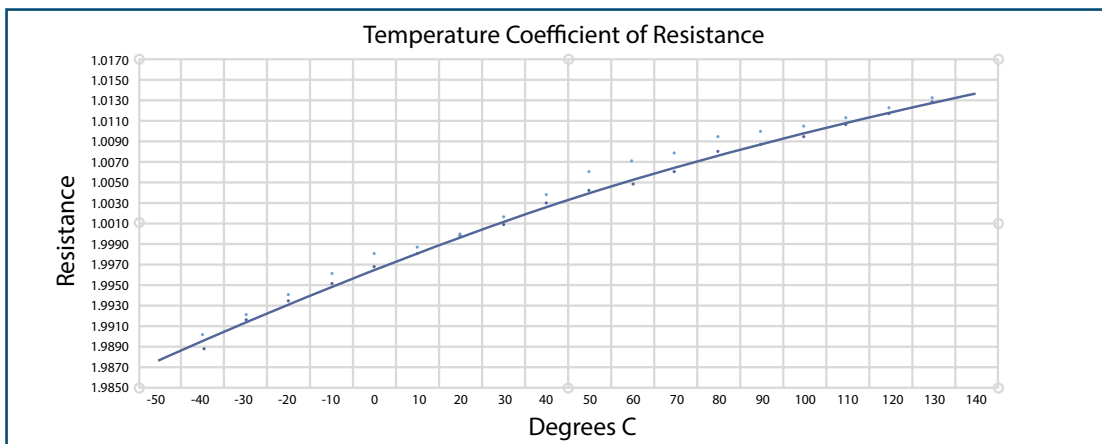

Figure 6. Data from Look Up Table Showing Resistance Drift with Temperature

APPLICATION NOTE

Accurate Measurements using Shunt Resistors and Current Sense Modules in High-Energy Storage Applications



CSS Series
Current Sense Resistors



CSM Series
Current Sense Resistors

Helping Ensure BMS Safety and Long Life

Currents of several hundred amperes are measured by BMS in various e-mobility applications during battery charging and discharging. The ability to measure current accurately provides critical information for safety and also helps to ensure long battery pack life. Using an ultra-low resistance shunt resistor together with a precision AFE can provide very accurate readings from very high to very low current levels with accuracy tolerances of less than 0.01 %. In addition, temperature sensing together with look-up tables from Bourns can improve measurement accuracy as the temperature increases.

This application note has provided a proven methodology to measure the cell voltage, temperature and current in order to determine the state of health of a battery cell. Key in this process are Bourns® current sense amplifiers featuring low offsets and high common mode voltages that enable high accuracy with the shunt being placed at the high end in 48 V applications.

Bourns® Model CSM2F Series shunt resistors are manufactured in an IATF-approved facility certified to build components for harsh environment applications such as in high energy BMS used in HEVs and BEVs.

www.bourns.com

BOURNS®

Americas: Tel +1-951 781-5500
Email americus@bourns.com

EMEA: Tel +36 88 520 390
Email eurocus@bourns.com

Asia-Pacific: Tel +886-2 256 241 17
Email asiacus@bourns.com