

Core Fit Reference

0329		EI-96	EI-125
		Metric	American

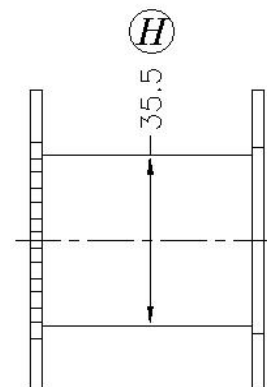
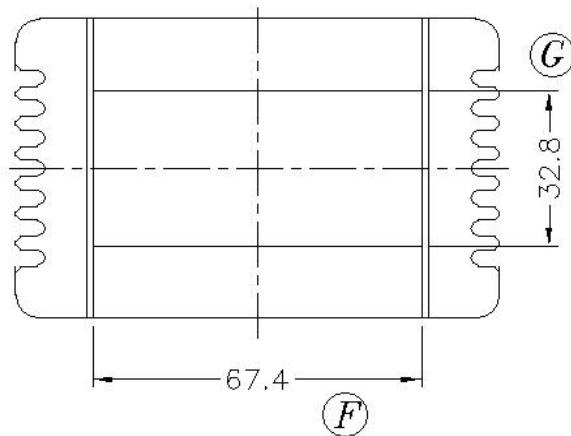
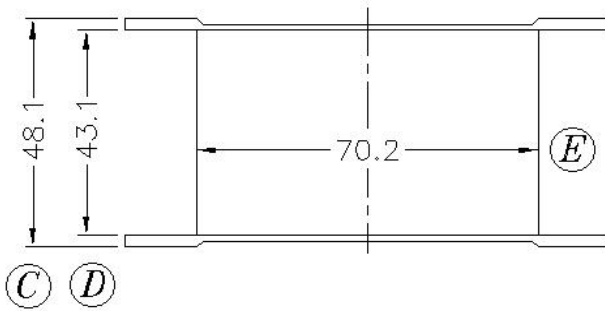
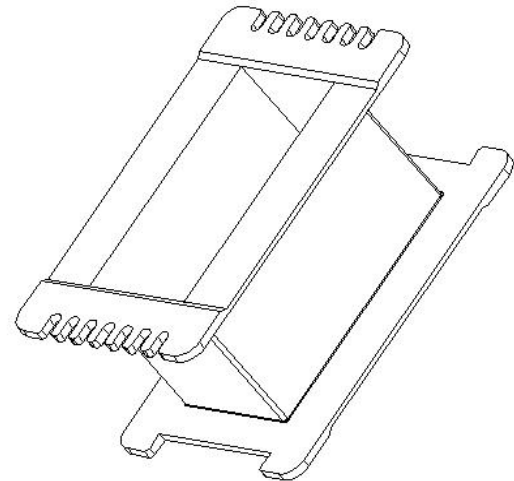
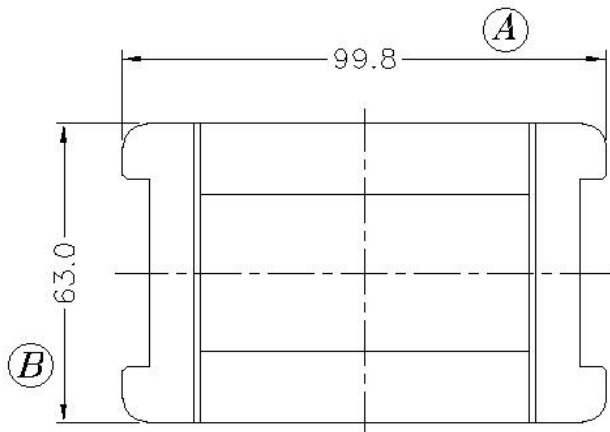

	Scale	Tolerance (mm)			Terminal Plating	Terminal Material	No of Terminals	
	None	0-4mm +/-0.1	4-16mm +/-0.2	16-60mm +/-0.3	100% Sn	CP Wire		

LODESTONE PACIFIC

CHINA FACTORY
www.lodestonepacific.com

Molding Material	UL File No.	Rating	Class
FR50	E41938	UL94-V0	F
Bobbin Part Number			Rev No
B-EIM96X67-1-GFN			1