

# Waterproof Circular Connectors

## Conforming to JIS-B-6015 and MIL-DTL-5015

### CE02-6A Series

DDK Ltd.

#### ◆ OUTLINE

CE02-6A series is a waterproof plug connector conforming to JIS-B-6015, a Japanese standard for electrical equipment for industrial tool machines, which has a ground contact to protect a circuit. This plug conforms to MIL-DTL-5015, a US military standard, as well then it is intermateable with D/MS series connectors available from our product lines. CE02-6A plug is suitable for the factory automation equipment, the tool machines and the electrical equipment in industry using under the rugged circumstances of moisture, oil and dust.



#### ◆ FEATURE

##### 1. First Make-Last Break Contact

CE02-6A plug has a piece of pre-mating ground contact having conductivity with the shell to protect a circuit. This contact will be connected with the mating half contact first before the other contacts and will unmate last on unmating the connectors.

##### 2. MIL-DTL-5015

The connectors are intermateable with MIL-DTL-5015 style connectors commonly used on the existing factory automation and other electrical equipment.

##### 3. Class IP67 Protection

This plug is designed to offer protection against moisture and oil. A gasket located between the coupling ring and the receptacle shell seals the connection. The waterproof backshells and cable clamps are available to complete the sealed connection. Mating with CE02-2A, D/MS3102A and CE05-2A receptacles will meet class IP67 protection.

#### ◆ SPECIFICATIONS

Service Rating	INST	A	D
Contact Size	# 16	# 12	# 8
Rated Current	13A / Contact	23A / Contact	46A / Contact
Rated Voltage	200V AC(r.m.s.)	500V AC(r.m.s.)	900V AC(r.m.s.)
	250V DC	700V DC	1,250V DC
Dielectric Withstanding Voltage	1000V AC(r.m.s.) at 1 minute.	2000V AC(r.m.s.) at 1 minute.	2800V AC(r.m.s.) at 1 minute.
Insulation Resistance	5000M Ω min. at 500V DC		
Waterproof Rating	IP67		
Operating Temperature	- 40°C to + 125°C		

#### ◆ MATERIAL / FINISH



Item	Material / Finish
Contact	Copper Alloy / Silver Plating
Insert	Diallyl Phthalate Resin (Blue)
Shell	Aluminum Alloy, Zinc Plating / Trivalent Chromium Treatment (Black)
Coupling Ring	Aluminum Alloy, Zinc Plating / Trivalent Chromium Treatment (Black)
Retaining Ring	Copper Alloy / Nickel Plating
Earth Rag	Copper Alloy / Silver Plating
Gasket	Synthetic Rubber

#### ◆ APPLICABLE CABLE SIZE

Contact		Applicable Cable Size		
Size	Bore of Solder Cup	Size	Nominal Sectional Area	Maximum Outer Diameter
# 16	1.76mm	# 22 ~ # 16	1.25mm <sup>2</sup>	1.6mm
# 12	2.85mm	# 14 ~ # 12	3.50mm <sup>2</sup>	2.5mm
# 8	5.21mm	# 10 ~ # 8	8.00mm <sup>2</sup>	4.5mm

Conforming Standard

JIS B 6015  
MIL-DTL-5015

Waterproof

IP 67

Lock Type

Threaded Coupling

▶ Insert Arrangements

Insert No.	10SL	18-10	18-12	20-15	20-29
Insert Arrangement					
Contact Size	# 16	# 12	# 16	# 12	# 16
Number of Contact	3	4	6	7	17
Ground Contact	C	D	D	D	N
Service Rating	A	A	A	A	A
Current Capacity	13A (29.2A)	23A (62.5A)	13A (43.6A)	23A (83.7A)	13A (81.7A)

Insert No.	20-14	22-22	22-23	22-10 (D)	24-10 (G)
Insert Arrangement					
Contact Size	# 16	# 8	# 12	# 8	# 8
Number of Contact	19	4	8	7	7
Ground Contact	N	D	D	D	G
Service Rating	A	A	D(H) A(Others)	A	A
Current Capacity	13A (88.9A)	46A (125.1A)	23A (90.1A)	46A (167.4A)	46A (167.4A)

Contact Size Symbol



\* Front view of pin contact and key position is standard.

\* The sign "●" stands for the ground contact.

\* Current capacity shows the maximum permitted current per contact.

Values in parenthesis show the total current capacities in each one of respective connectors.

▶ Alternate Insert Positions

Insert No.	Contact Size/ Number of Contact	Alternate Insert Key Position			
		W	X	Y	Z
10SL-3	# 16 / 3				
18-10	# 12 / 4		120°	240°	
18-12	# 16 / 6	80°			280°
20-15	# 12 / 7	80°			280°
20-29	# 16 / 17	80°			280°
22-14	# 16 / 19	80°			280°
22-22	# 8 / 4		110°	250°	
22-23	# 12 / 8				
24-10	# 8 / 7				280°

To avoid cross-mating problems in applications requiring the use of more than one connector of the same size and insert arrangement, alternate insert positions are available as indicated or as shown in the diagram below.

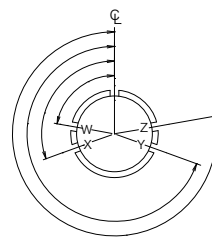

Front View of Pin Insert

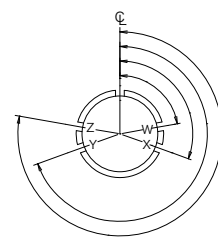

Front View of Socket Insert

▶ Plug Connector

**CE02-6A18-12DSW-D(R1)**

① ② ③ ④ ⑤ ⑥ ⑦

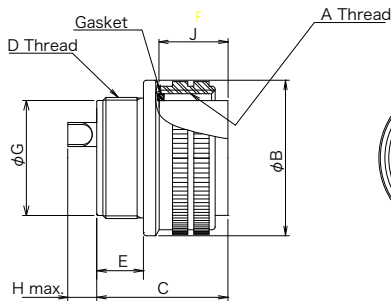

① Shell Style	6A : Straight Plug
② Shell Size	10SL, 18, 20, 22 and 24
③ Insert Arrangement	Refer to page 2.
④ Ground Contact	Refer to page 2.
⑤ Contact Style	S : Socket Contact
⑥ Alternate Insert Key Positions	Omit : Standard Position W,X,Y,Z : Alternate Position
⑦ Finish	D : Trivalent Chromium Treatment(Black)

Part Number	A	B	C	D	E	G	H max.	J
CE02-6A10SL-3CS-D(R1)	5/8-24UNEF-2B	22.2	23.3	9/16-24UNEF-2A	7.5	12.5	7.0	13.2
CE02-6A18-10DS-D(R1)	1 1/8-18UNEF-2B	34.1	33.7	1-20UNEF-2A	11.7	23.5	7.5	19.0
CE02-6A18-12DS-D(R1)							7.0	
CE02-6A20-15DS-D(R1)	1 1/4-18UNEF-2B	37.3	34.1	1 1/8-18UNEF-2A	12.2	26.8	7.5	19.0
CE02-6A20-29NS-D(R1)							7.0	
CE02-6A22-14NS-D(R1)	1 3/8-18UNEF-2B	40.5	34.1	1 1/4-18UNEF-2A	12.2	29.9	7.0	19.0
CE02-6A22-22DS-D(R1)							10.0	
CE02-6A22-23DS-D(R1)							7.5	
CE02-6A24-10DS-D(R1)	1 1/2-18UNEF-2B	43.6	36.6	1 3/8-18UNEF-2A	13.4	32.8	8.5	19.4
CE02-6A24-10GS-D(R1)							8.5	

▶ Waterproof Straight Backshell

**CE02-18BS-S-D(R1)**

① ② ③ ④ ⑤

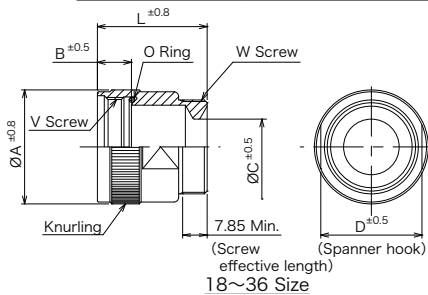
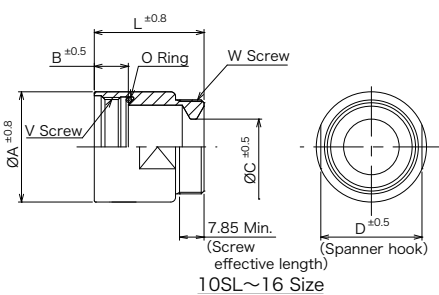

① Shell Size	10SL, 18, 20, 22 and 24
② Model	B : Backshell
③ Style	S : Straight
④ Waterproof	S : Waterproof
⑤ Finish	D : Trivalent Chromium Treatment(Black)

**MATERIAL/FINISH**

Aluminum Alloy / Black Trivalent Chromium Treatment

Waterproof straight backshell is used to retain the cable when a conduit is not used.

Shell Size	Part Number	L	A	B	C	D	V	W
10SL	CE02-10SLBS-S-D(R1)	20.2	18.6	6.5	6.6	17.9	9/16-24UNEF-2B	5/8-24UNEF-2A
18	CE02-18BS-S-D(R1)	31.0	30.4	10.5	16.22	26.73	1-20UNEF-2B	1-20UNEF-2A
20	CE02-20BS-S-D(R1)	35.0	34.9	10.9	17.8	31.6	1 1/8-18UNEF-2B	1 3/16-18UNEF-2A
22	CE02-22BS-S-D(R1)	35.0	36.4	10.9	17.8	32.4	1 1/4-18UNEF-2B	1 3/16-18UNEF-2A
24	CE02-24BS-S-D(R1)	40.5	40.0	12.2	21.0	36.6	1 3/8-18UNEF-2B	1 7/16-18UNEF-2A

© Specifications and/or dimensions in this catalog are subject to change without notice. © Your checking the latest specifications with our drawings would be highly appreciated.

▶ Waterproof Cable Clamp

CE3057-10A-1-D(R1)

① ② ③

① Clamp Size	4A, 10A, 12A, 16A
② Bushing Size	Rubber Bushing (Refer to the applicable cable size.)
③ Finish	D : Trivalent Chromium Treatment (Black)

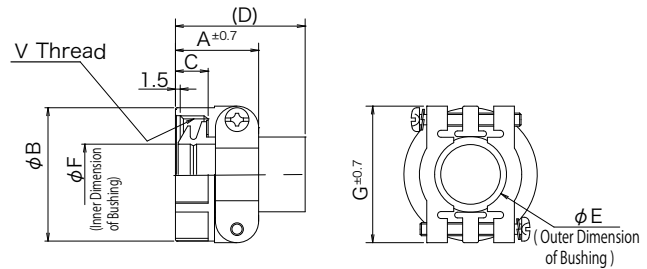

CE3057-□□ A-□ -D is a waterproof cable clamp for use with a plug. The cable clamp has a waterproof rubber bushing. Make sure to use a cable meeting one of the applicable cable size ranges as shown below. The cable clamp should be used together with a waterproof backshell.

Part Number	Applicable Shell Size	A	B	C	(D)	E	F	G	V	Bushing P/N	Applicable Cable
CE3057-4A-1-D(R1)	10SL,12S	20.62	20.6	10.31	(41.3)	8.0	5.6	22.2	5/8-24UNEF-2B	CE3420-4-1(R1)	φ 3.6 ~ φ 5.6
CE3057-10A-1-D(R1)	18	23.83	30.1	10.31	(41.3)	15.8	14.1	31.7	1-20UNEF-2B	CE3420-10-1(R1)	φ 10.5 ~ φ 14.1
11.0							CE3420-10-2(R1)			φ 8.5 ~ φ 11.0	
8.7							CE3420-10-3(R1)			φ 6.5 ~ φ 8.7	
CE3057-12A-1-D(R1)	20	23.83	35.0	10.31	(41.3)	19.0	16.0	37.3	1 3/16-18UNEF2B	CE3420-12-1(R1)	φ 12.5 ~ φ 16.0
13.0							CE3420-12-2(R1)			φ 9.5 ~ φ 13.0	
10.0							CE3420-12-3(R1)			φ 6.8 ~ φ 10.0	
17.0							CE3420-12-7(R1)			φ 14.5 ~ φ 17.0	
CE3057-16A-1-D(R1)	24	26.19	42.1	10.31	(41.3)	23.8	19.1	42.9	1 7/16-18UNEF-2B	CE3420-16-1(R1)	φ 15.0 ~ φ 19.1
15.5							CE3420-16-2(R1)			φ 13.0 ~ φ 15.5	
21.5							CZY005-GB-3(R1)			φ 19.1 ~ φ 21.5	
20.0							CE3420-16-6(R1)			φ 18.5 ~ φ 20.0	
13.5							CE3420-16-7(R1)			φ 11.5 ~ φ 13.5	
12.5							CZY005-GB-5(R1)			φ 10.5 ~ φ 12.5	

※ Depending on the cable used, the contact between bushing and cable may be discolored.

▶ Waterproof Rubber Bushing

CE3420-10-1(R1)

① ②

① Cable Clamp Size	4, 10, 12, 16
② Bushing Size	Refer to table 1.

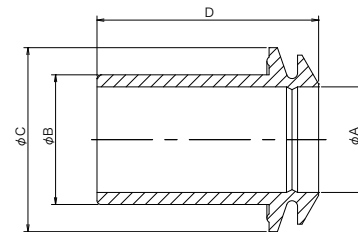

CE3420-□□ A-□ is the rubber bushing which combines with the cable clamp(CE3057-□ □ A-□ -D(R1)) to constrict the cable for waterproof.

Table 1

Part Number	φ A	φ B	φ C	D	Friction Washer
CE3420-4-1(R1)	5.6	7.5	12.9	38.3	MS3057-4W
CE3420-10-1(R1)	14.1	15.5	22.2	38.5	MS3057-10W
CE3420-10-2(R1)	11.0				
CE3420-10-3(R1)	8.7				
CE3420-12-1(R1)	16.0	18.6	26.9	39.3	MS3057-12W
CE3420-12-2(R1)	13.0				
CE3420-12-3(R1)	10.0				
CE3420-12-7(R1)	17.0				
CE3420-16-1(R1)	19.1	23.4	33.2	40.0	MS3057-16W
CE3420-16-2(R1)	15.5				
CE3420-16-6(R1)	20.0				
CE3420-16-7(R1)	13.5				

Note1:The friction washer is available separately.

Note2:Depending on the cable used, the contact between bushing and cable may be discolored.

© Specifications and/or dimensions in this catalog are subject to change without notice. © Your checking the latest specifications with our drawings would be highly appreciated.