

# VS-09-BU-DSUB-EG - Contact insert



1688803

<https://www.phoenixcontact.com/us/products/1688803>

Please be informed that the data shown in this PDF document is generated from our online catalog. Please find the complete data in the user documentation. Our general terms of use for downloads are valid.

D-SUB contact insert, shell size 1, with nine signal contacts, type of contact socket, with solder cup, straight, fixing with a 3 mm hole, for panel mounting frame and sleeve housing VS-09-...



## Your advantages

- Compatible with IP67 sleeve housing and panel-mount frame
- Easy assembly
- D-SUB 9 connection

## Commercial data

Item number	1688803
Packing unit	10 pc
Minimum order quantity	10 pc
Sales key	AB19
Product key	ABNCAB
Catalog page	Page 210 (C-2-2013)
GTIN	4017918822934
Weight per piece (including packing)	11.06 g
Weight per piece (excluding packing)	6.09 g
Customs tariff number	85366990
Country of origin	DE

# VS-09-BU-DSUB-EG - Contact insert



1688803

<https://www.phoenixcontact.com/us/products/1688803>

## Technical data

### Product properties

Product type	Female insert
Type	D-SUB
Number of positions	9
Connection profile	D-SUB
Number of slots	1
Type	Socket
Shielded	yes

### Insulation characteristics

Overvoltage category	III
Degree of pollution	2

### Electrical properties

Rated voltage in acc. with IEC 61076-2-101	400 V
Rated voltage (III/3)	125 V
Rated surge voltage	1 kV
Rated current	5 A (at 20 °C)
Test voltage	1200 V
Transmission medium	Copper
Power transmission	Power

### Connection data

#### Connection technology

Connection method	Solder cup
-------------------	------------

### Dimensions

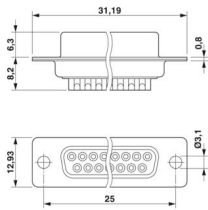
Dimensional drawing	
Width	14.5 mm
Height	31.19 mm
Length	12.93 mm

### Material specifications

Flammability rating according to UL 94	V0
Housing material	Metal
Housing surface material	metal-plated

# VS-09-BU-DSUB-EG - Contact insert



1688803

<https://www.phoenixcontact.com/us/products/1688803>

Contact material	Copper alloy
Contact surface material	Gold
Contact carrier material	PBT-GF

## Mechanical properties

### Mechanical data

Insertion/withdrawal cycles	$\geq 50$
Insertion force per signal contact	$\leq 3.40 \text{ N}$

## Environmental and real-life conditions

### Ambient conditions

Degree of protection	IP20
Ambient temperature (operation)	-55 °C ... 125 °C

## Mounting

Mounting type	Screw mounting
---------------	----------------

# VS-09-BU-DSUB-EG - Contact insert

1688803

<https://www.phoenixcontact.com/us/products/1688803>

## Drawings

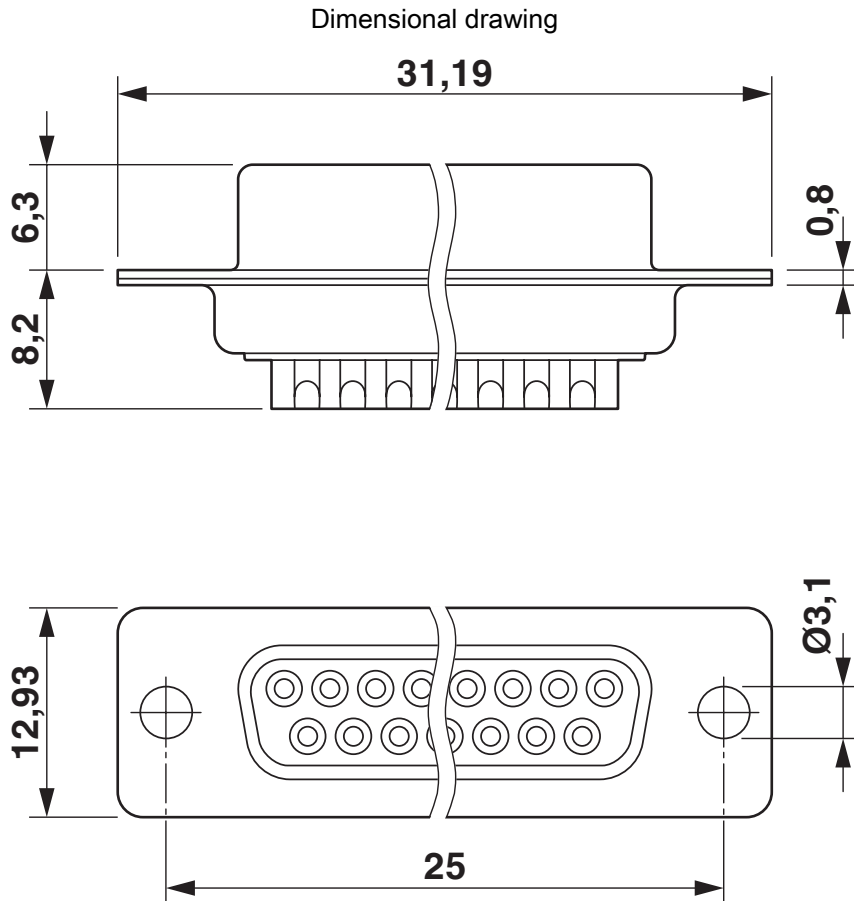

D-SUB contact insert

# VS-09-BU-DSUB-EG - Contact insert



1688803

<https://www.phoenixcontact.com/us/products/1688803>

Schematic diagram

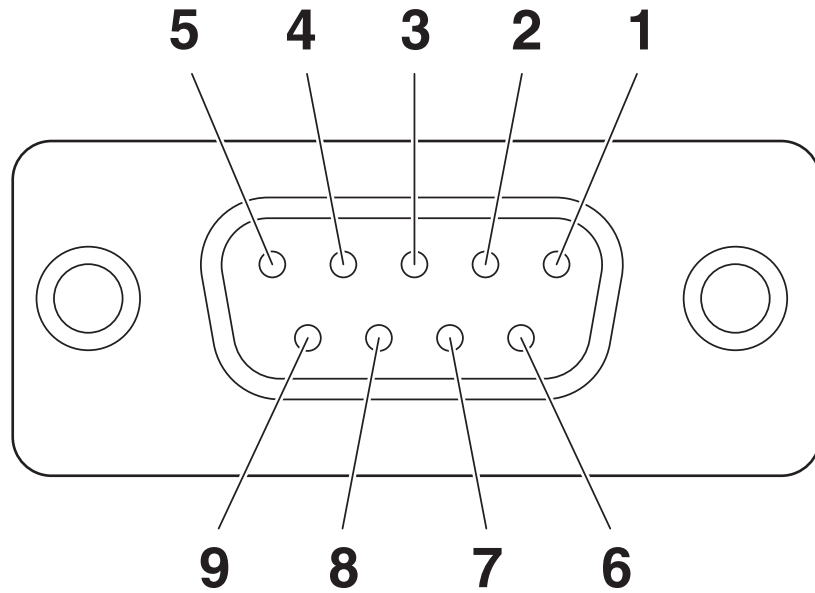

# VS-09-BU-DSUB-EG - Contact insert



1688803

<https://www.phoenixcontact.com/us/products/1688803>

## Approvals

To download certificates, visit the product detail page: <https://www.phoenixcontact.com/us/products/1688803>



**UL Recognized**

Approval ID: FILE E 118976

# VS-09-BU-DSUB-EG - Contact insert



1688803

<https://www.phoenixcontact.com/us/products/1688803>

## Classifications

### ECLASS

ECLASS-11.0	27440217
ECLASS-12.0	27440217
ECLASS-13.0	27440217

### ETIM

ETIM 9.0	EC000438
----------	----------

### UNSPSC

UNSPSC 21.0	39121400
-------------	----------

# VS-09-BU-DSUB-EG - Contact insert



1688803

<https://www.phoenixcontact.com/us/products/1688803>

## Environmental product compliance

### EU RoHS

Fulfills EU RoHS substance requirements	Yes
Exemption	6(c)

### China RoHS

Environment friendly use period (EFUP)	EFUP-50
	An article-related China RoHS declaration table can be found in the download area for the respective article under "Manufacturer declaration". For all articles with EFUP-E, no China RoHS declaration table issued and required.

### EU REACH SVHC

REACH candidate substance (CAS No.)	Lead(CAS: 7439-92-1)
SCIP	b5463eea-8d89-4a9a-9875-4167abe9b524



# VS-09-BU-DSUB-EG - Contact insert

1688803

<https://www.phoenixcontact.com/us/products/1688803>



## Accessories

### CUC-DST-GPME-S/DSSC9 - D-SUB sleeve housings

1419705

<https://www.phoenixcontact.com/us/products/1419705>

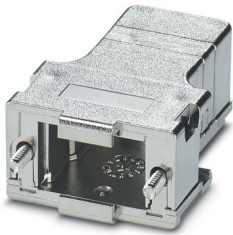

D-SUB sleeve housings, degree of protection: IP20, material: ABS, metal-plated, cable outlet: straight, housing size: 1, color: Bare metallic

---

### CUC-DST-GPME-A/DSSC9 - D-SUB sleeve housings

1419706

<https://www.phoenixcontact.com/us/products/1419706>

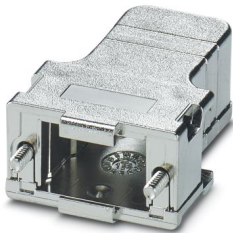

D-SUB sleeve housings, degree of protection: IP20, material: ABS, metal-plated, cable outlet: angled, housing size: 1, color: Bare metallic

# VS-09-BU-DSUB-EG - Contact insert

1688803

<https://www.phoenixcontact.com/us/products/1688803>



## CUC-DST-GZNI-S/DSSC9 - D-SUB sleeve housings

1419722

<https://www.phoenixcontact.com/us/products/1419722>

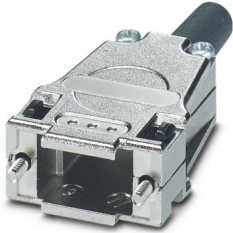

D-SUB sleeve housings, degree of protection: IP20, material: Zinc die-cast, cable outlet: straight, housing size: 1, color: Bare metallic

---

## CUC-DST-GZNI-A/DSSC9 - D-SUB sleeve housings

1419723

<https://www.phoenixcontact.com/us/products/1419723>

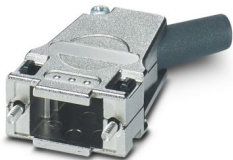

D-SUB sleeve housings, degree of protection: IP20, material: Zinc die-cast, cable outlet: angled, housing size: 1, color: Bare metallic

## VS-09-BU-DSUB-EG - Contact insert

1688803

<https://www.phoenixcontact.com/us/products/1688803>



## VS-09-T-2M16 - D-SUB sleeve housings

1688353

<https://www.phoenixcontact.com/us/products/1688353>



D-SUB sleeve housings, degree of protection: IP67, material: PA, cable outlet: angled, housing size: 1, color: gray

---

## VS-09-A - Panel mounting frames

1688366

<https://www.phoenixcontact.com/us/products/1688366>



D-SUB panel mounting frame, shell size 1, IP67 degree of protection

## VS-09-BU-DSUB-EG - Contact insert

1688803

<https://www.phoenixcontact.com/us/products/1688803>



## CUC-SCHRAUBE-5,5:360 - Screw

1421711

<https://www.phoenixcontact.com/us/products/1421711>

Screw, design: Hexagonal, color: Bare metallic



---

## VS-09-ST-DSUB-EG - Contact insert

1688793

<https://www.phoenixcontact.com/us/products/1688793>

D-SUB contact insert, shell size 1, with nine signal contacts, type of contact pin, with solder cup, straight, fixing with a 3 mm hole, for panel mounting frame and sleeve housing VS-09-...



---

Phoenix Contact 2024 © - all rights reserved  
<https://www.phoenixcontact.com>

Phoenix Contact USA  
586 Fulling Mill Road  
Middletown, PA 17057, United States  
(+717) 944-1300  
[info@phoenixcon.com](mailto:info@phoenixcon.com)