NI-9232

Specifications

2022-10-07

Contents

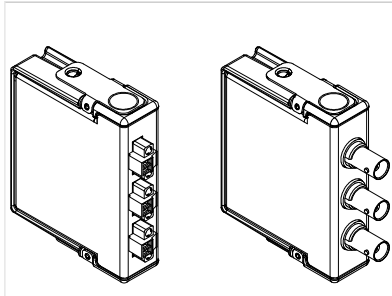

NI 9232 Datasheet.....	3
NI-9232 Specifications.....	12

NI 9232 Datasheet



- Screw-terminal or BNC connectivity
- Software-selectable AC/DC coupling
- Software-selectable IEPE signal conditioning (0 mA or 4 mA)
- Smart TEDS sensor compatibility
- 60 V DC, CAT I, channel-to-earth isolation

The NI-9232 is a 3-channel C Series dynamic signal acquisition module for making industrial measurements from integrated electronic piezoelectric (IEPE) and non-IEPE sensors with NI CompactDAQ or NI CompactRIO systems.

 <p>Kit Contents</p>	<ul style="list-style-type: none"> • NI 9232 • NI 9232 Getting Started Guide
 <p>Accessories</p>	<p>Required</p> <ul style="list-style-type: none"> • EMI suppression ferrite (782802-01) (for screw terminal) <p>Recommended</p> <ul style="list-style-type: none"> • NI 9971 Backshell Kit (for screw terminal)

C SERIES DYNAMIC SIGNAL ACQUISITION MODULE COMPARISON							
Product Name	Signal Ranges	Channels	Sample Rate	Input Configurations	Noise at Maximum Sample Rate	Connectivity	Isolation Continuous
NI 9218	±5 V	2	51.2 kS/s/ch	IEPE with AC Coupling	50 μ Vrms	9-Position DSUB, LEMO	60 VDC Ch-Ch
NI 9230	±30 V	3	12.8 kS/s/ch	IEPE with AC Coupling, AC Coupling, DC Coupling	106 μ Vrms	Screw Terminal, BNC	60 VDC Ch-Earth
NI 9232	±30 V	3	102.4 kS/s/ch	IEPE with AC Coupling, AC Coupling, DC Coupling	251 μ Vrms	Screw Terminal, BNC	60 VDC Ch-Earth
NI 9234	±5 V	4	51.2 kS/s/ch	IEPE with AC Coupling, AC Coupling, DC Coupling	50 μ Vrms	BNC	None
NI 9250	±5 V	2	102.4 kS/s/ch	IEPE with AC Coupling, AC Coupling, DC Coupling	9.7 μ Vrms	BNC	None
NI 9251	3 Vrms (\pm 4.243 V)	2	102.4 kS/s/ch	AC Coupling, DC Coupling	8.5 μ Vrms	mini XLR	None

NI C Series Overview



NI provides more than 100 C Series modules for measurement, control, and communication applications. C Series modules can connect to any sensor or bus and allow for high-accuracy measurements that meet the demands of advanced data acquisition and control applications.

- Measurement-specific signal conditioning that connects to an array of sensors and signals
- Isolation options such as bank-to-bank, channel-to-channel, and channel-to-earth ground
- -40 °C to 70 °C temperature range to meet a variety of application and environmental needs

- Hot-swappable

The majority of C Series modules are supported in both CompactRIO and CompactDAQ platforms and you can move modules from one platform to the other with no modification.

CompactRIO



CompactRIO combines an open-embedded architecture with small size, extreme ruggedness, and C Series modules in a platform powered by the NI LabVIEW reconfigurable I/O (RIO) architecture. Each system contains an FPGA for custom timing, triggering, and processing with a wide array of available modular I/O to meet any embedded application requirement.

CompactDAQ

CompactDAQ is a portable, rugged data acquisition platform that integrates connectivity, data acquisition, and signal conditioning into modular I/O for directly interfacing to any sensor or signal. Using CompactDAQ with LabVIEW, you can easily customize how you acquire, analyze, visualize, and manage your measurement data.



Software

LabVIEW Professional Development System for Windows

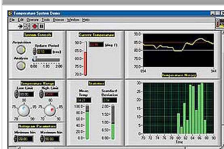

- Use advanced software tools for large project development
- Generate code automatically using DAQ Assistant and Instrument I/O Assistant

LabVIEW Professional Development System for Windows

- Use advanced measurement analysis and digital signal processing
- Take advantage of open connectivity with DLLs, ActiveX, and .NET objects
- Build DLLs, executables, and MSI installers

NI LabVIEW FPGA Module

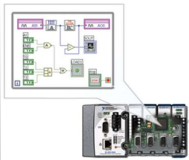

- Design FPGA applications for NI RIO hardware
- Program with the same graphical environment used for desktop and real-time applications
- Execute control algorithms with loop rates up to 300 MHz
- Implement custom timing and triggering logic, digital protocols, and DSP algorithms
- Incorporate existing HDL code and third-party IP including Xilinx IP generator functions
- Purchase as part of the LabVIEW Embedded Control and Monitoring Suite

NI LabVIEW Real-Time Module

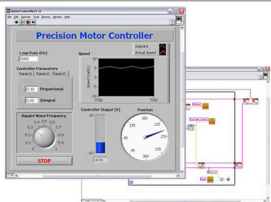

- Design deterministic real-time applications with LabVIEW graphical programming
- Download to dedicated NI or third-party hardware for reliable execution and a wide selection of I/O
- Take advantage of built-in PID control, signal processing, and analysis functions
- Automatically take advantage of multicore CPUs or set processor affinity manually
- Take advantage of real-time OS, development and debugging support, and board support
- Purchase individually or as part of a LabVIEW suite

Circuitry

The NI-9232 analog input channels are referenced to an isolated ground through a 50 Ω resistor. Each channel is protected from overvoltages. The input signal on each channel is buffered, conditioned, and then sampled by an isolated 24-bit Delta-Sigma ADC. You can configure each channel in software for AC or DC coupling. For channels set to AC coupling, you can turn the IEPE excitation current on or off. Refer to the software help for information about configuring channels on the NI-9232.

Figure 1. Input Circuitry for One Channel

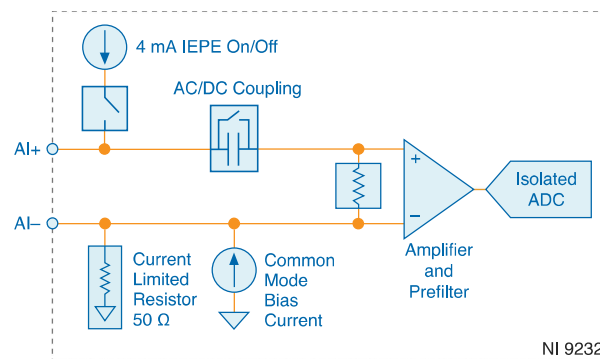

The NI-9232 also has TEDS circuitry. For more information about TEDS, visit ni.com/info and enter the Info Code rdteds.

Filtering

The NI-9232 uses a combination of analog and digital filtering to provide an accurate representation of in-band signals while rejecting out-of-band signals. The filters discriminate between signals based on the frequency range, or bandwidth, of the signal. The three important bandwidths to consider are the passband, the stopband, and the alias-free bandwidth.

The NI-9232 represents signals within the passband, as quantified primarily by passband ripple and phase nonlinearity. All signals that appear in the alias-free bandwidth are either unaliased signals or signals that have been filtered by at least the amount of the stopband rejection.

Passband

The signals within the passband have frequency-dependent gain or attenuation. The small amount of variation in gain with respect to frequency is called the passband flatness. The digital filters of the NI-9232 adjust the frequency range of the passband to match the data rate. Therefore, the amount of gain or attenuation at a given frequency depends on the data rate.

Stopband

The filter significantly attenuates all signals above the stopband frequency. The primary goal of the filter is to prevent aliasing. Therefore, the stopband frequency scales precisely with the data rate. The stopband rejection is the minimum amount of attenuation applied by the filter to all signals with frequencies within the stopband.

Alias-Free Bandwidth

Any signal that appears in the alias-free bandwidth of the NI-9232 is not an aliased artifact of signals at a higher frequency. The alias-free bandwidth is defined by the ability of the filter to reject frequencies above the stopband frequency, and it is equal to the data rate minus the stopband frequency.

Data Rates

The frequency of a master timebase (f_M) controls the data rate (f_s) of the NI-9232.

Internal Master Timebase

The NI-9232 includes an internal master timebase with a frequency of 13.1072 MHz. When using the internal master timebase, the result is data rates of 102.4 kS/s, 51.2 kS/s, 34.13 kS/s, 25.6 kS/s, and so on down to 0.98 kS/s, depending on the decimation rate and the value of the clock divider. However, the data rate must remain within the appropriate data rate range.

The following equation provides the available data rates of the NI-9232:

$$f_s = \frac{f_M}{2 \times m \times n}$$

where

- f_s is the data rate
- f_M is the master timebase
- m is the decimation rate
- n is the clock divider from 1 to 26

There are multiple combinations of clock divider and decimation rate that yield the same data rate. The software always picks the highest decimation rate for the selected data rate.

Data Rates with the Internal Master Timebase

The following table lists the available data rates with the internal master timebase.

f_s (kS/s)	Decimation Rate	Clock Divider
102.40	64	1
51.20	128	1
34.13	64	3
25.60	256	1
20.48	64	5
17.07	128	3
14.63	64	7
12.80	256	2
11.38	64	9
10.24	128	5
9.31	64	11
8.53	256	3
7.88	64	13
7.31	128	7
6.83	64	15

f_s (kS/s)	Decimation Rate	Clock Divider
6.40	256	4
6.02	64	17
5.69	128	9
5.39	64	19
5.12	256	5
4.88	64	21
4.65	128	11
4.45	64	23
4.27	256	6
4.10	64	25
3.94	128	13
3.66	256	7
3.41	128	15
3.20	256	8
3.01	128	17
2.84	256	9
2.69	128	19
2.56	256	10
2.44	128	21
2.33	256	11
2.23	128	23
2.13	256	12
2.05	128	25
1.97	256	13
1.83	256	14
1.71	256	15
1.60	256	16
1.51	256	17
1.42	256	18
1.35	256	19
1.28	256	20

f_s (kS/s)	Decimation Rate	Clock Divider
1.22	256	21
1.16	256	22
1.11	256	23
1.07	256	24
1.02	256	25
0.98	256	26

Table 1. Available Data Rates with the Internal Master Timebase

External Master Timebase

The NI-9232 also can accept an external master timebase or export its own master timebase. To synchronize the data rate of an NI-9232 with other modules that use master timebases to control sampling, all of the modules must share a single master timebase source. When using an external timebase with a frequency other than 13.1072 MHz, the NI-9232 has a different set of data rates. Refer to the software help for information about configuring the master timebase source for the NI-9232.

Note The NI 9151 R Series Expansion chassis does not support sharing timebases between modules.

NI-9232 Specifications

The following specifications are typical for the range -40 °C to 70 °C unless otherwise noted.

Caution Do not operate the NI-9232 in a manner not specified in this document. Product misuse can result in a hazard. You can compromise the safety protection built into the product if the product is damaged in any way. If the product is damaged, return it to NI for repair.

Input Characteristics

Number of channels	3 analog input channels
ADC resolution	24 bits
Type of ADC	Delta-Sigma (with analog prefiltering)
Sampling mode	Simultaneous
Type of TEDS supported	IEEE 1451.4 TEDS Class I
TEDS capacitive drive	3000 pF
Internal master timebase (f_M)	
Frequency	13.1072 MHz
Accuracy	±100 ppm
Data rate range (f_S) using internal master timebase	

Minimum	0.985 kS/s
Maximum	102.4 kS/s
Data rate range (f_s) using external master timebase	
Minimum	0.977 kS/s
Maximum	102.73 kS/s

Figure 2. Data Rates (f_s)

$$\frac{f_M}{2 \times m \times n} \quad \frac{f_M}{2 \times m \times n}$$

Input coupling	AC/DC (software-selectable)
AC cutoff frequency	
-3 dB	0.1 Hz
-0.1 dB	0.87 Hz maximum

Figure 3. AC Cutoff Frequency Response

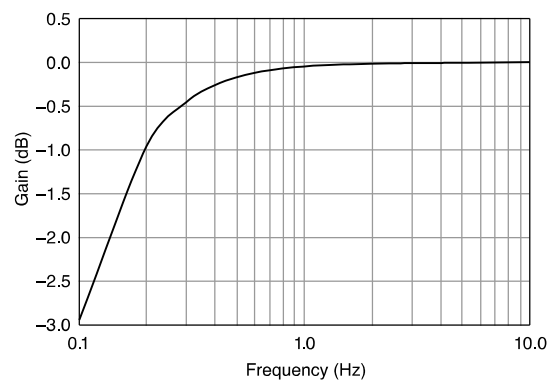

DC voltage input range	
Minimum	± 30.87 V

Typical	±31.5 V	
Maximum	±32.13 V	
AC voltage full-scale range^[1]		
Minimum	±30.87 Vpk	
Typical	±31.5 Vpk	
Maximum	±32.13 Vpk	
Channel-to-channel common-mode voltage range (AI- to AI-)		±1 V maximum
IEPE excitation current (software-selectable on/off)		
Minimum	4 mA	
Typical	4.25 mA	
IEPE excitation noise		100 nArms
IEPE compliance voltage		22 V minimum

If you are using an IEPE sensor, use the following equation to make sure your configuration meets the IEPE compliance voltage range.

Figure 4. IEPE Compliance Voltage Range

$$(0.67 \times V_{\text{common-mode}} + V_{\text{bias}} \pm V_{\text{full-scale}}) \quad (0.67 \times V_{\text{common-mode}} + V_{\text{bias}} \pm V_{\text{full-scale}})$$

where

- $V_{\text{common-mode}}$ is the channel-to-channel common-mode voltage across two or more channels

- V_{bias} is the bias voltage of the IEPE sensor
- $V_{\text{full-scale}}$ is the full-scale voltage of the IEPE sensor

Note This equation must resolve to 0 V to 22 V.

IEPE fault detection^[2]

Short circuit $V_{AI} < 1.5 \text{ V}$

Open loop $V_{AI} > 24 \text{ V}$

Overvoltage protection $\pm 45 \text{ V}$ for a low impedance source connected between any two terminals

Input delay

64x decimation $30/f_s + 3.0 \mu\text{s}$

128x decimation $29/f_s + 3.0 \mu\text{s}$

256x decimation $28/f_s + 3.0 \mu\text{s}$

Measurement Conditions		Percent of Reading (Gain Error)	Percent of Range ^[3] (Offset Error) ^[4]
Calibrated	Maximum (-40 °C to 70 °C)	$\pm 0.60\%$	$\pm 0.23\%$
	Typical (23 °C, ± 5 °C)	$\pm 0.10\%$	$\pm 0.023\%$
Uncalibrated ^[5]	Maximum (-40 °C to 70 °C)	$\pm 1.50\%$	$\pm 0.59\%$
	Typical (23 °C, ± 5 °C)	$\pm 0.40\%$	$\pm 0.12\%$

Table 2. Accuracy

Stability

Gain drift $\pm 25 \text{ ppm}/^\circ\text{C}$

Offset drift (DC coupled)	$\pm 320 \mu\text{V}/^\circ\text{C}$	
Frequency Band	20 Hz to 40.96 kHz	
	Typical	Maximum
Channel-to-channel	25 mdB	120 mdB

Table 3. Gain Matching (Calibrated)

Frequency Band	20 Hz to 40.96 kHz
Channel-to-channel	$(0.022^\circ/\text{kHz} \times f_{\text{in}}) + 0.045^\circ$
Module-to-module	$(0.022^\circ/\text{kHz} \times f_{\text{in}}) + 0.045^\circ + (360^\circ \times f_{\text{in}} / f_{\text{M}})$

Table 4. Phase Matching (Maximum)

Passband frequency	$0.4 \cdot f_{\text{s}}$	
Frequency Band	20 Hz to 20.48 kHz	20 Hz to 40.96 kHz
Typical	70 mdB	75 mdB
Maximum	75 mdB ^[6]	100 mdB ^[7]

Table 5. Flatness (Peak-to-Peak)

Frequency Band	20 Hz to 20.48 kHz	20 Hz to 40.96 kHz
AC Coupled	0.31°	0.31°
DC Coupled	0.025°	0.19°

Table 6. Phase Nonlinearity (Maximum)

Stopband	
Frequency	$0.5 \cdot f_{\text{s}}$
Rejection	120 dB
Alias-free bandwidth	$0.4 \cdot f_{\text{s}}$

Oversample rate	$64 \cdot f_s$, $128 \cdot f_s$, and $256 \cdot f_s$		
Rejection at oversample rate^[8]			
$f_s = 10.24$ kS/s	95 dB at 1.311 MHz		
$f_s = 102.4$ kS/s	120 dB at 6.554 MHz		
Crosstalk ($f_{in} = 1$ kHz)	-125 dB		
CMRR			
Channel-to-channel ($f_{in} \leq 1$ kHz)	56 dB		
Channel-to-earth ($f_{in} = 60$ Hz)	107 dB		
SFDR ($f_{in} = 1$ kHz, -60 dBFS)			
$f_s = 102.4$ kS/s	120 dBFS		
$f_s = 51.2$ kS/s	123 dBFS		
$f_s = 25.6$ kS/s	126 dBFS		
Data Rate	102.4 kS/s	51.2 kS/s	25.6 kS/s
AC coupled	251 μ Vrms	171 μ Vrms	127 μ Vrms
DC coupled	223 μ Vrms	150 μ Vrms	112 μ Vrms

Table 7. Input Noise

Data Rate	102.4 kS/s	51.2 kS/s	25.6 kS/s
AC coupled	99 dBFS	102 dBFS	105 dBFS
DC coupled	100 dBFS	103 dBFS	106 dBFS

Table 8. Dynamic range ($f_{in} = 1$ kHz, -60 dBFS)

Input impedance		
Differential		324 k Ω
AI- to isolated ground		50 Ω

Input Amplitude	1 kHz	10 kHz
-10.5424 dBFS	-95 dB	-85 dB
-20 dBFS	-95 dB	-85 dB

Table 9. Total Harmonic Distortion (THD)

Intermodulation distortion (-10.5424 dBFS)	
DIN 250 Hz/8 kHz4:1 amplitude ratio	-80 dB
CCIF 11 kHz/12 kHz1:1 amplitude ratio	-100 dB

Power Requirements

Power consumption from chassis	
Active mode	1 W maximum
Sleep mode	25 μ W maximum

Thermal dissipation (at 70 °C)	
Active mode	1 W maximum
Active mode (BNC variant)	1.5 W maximum
Sleep mode	25 μ W maximum

Physical Characteristics

Screw-terminal wiring

Gauge	0.05 mm ² to 1.5 mm ² (30 AWG to 14 AWG) copper conductor wire	
Wire strip length	6 mm (0.24 in.) of insulation stripped from the end	
Temperature rating	90 °C, minimum	
Torque for screw terminals	0.22 N · m to 0.25 N · m (1.95 lb · in. to 2.21 lb · in.)	
Wires per screw terminal	One wire per screw terminal; two wires per screw terminal using a 2-wire ferrule	
Ferrules	0.25 mm ² to 1.5 mm ²	
Connector securement		
Securement type	Screw flanges provided	
Torque for screw flanges	0.2 N · m (1.80 lb · in.)	

Safety Voltages

Connect only voltages that are within the following limits.

Isolation		
Channel-to-channel	None	
Channel-to-earth ground		

Continuous	60 V DC, Measurement Category I
Withstand	1,000 V RMS, verified by a 5 s dielectric withstand test

Hazardous Locations

U.S. (UL)	Class I, Division 2, Groups A, B, C, D, T4; Class I, Zone 2, AEx nA IIC T4 Gc
Canada (C-UL)	Class I, Division 2, Groups A, B, C, D, T4; Class I, Zone 2, Ex nA IIC T4 Gc
Europe (ATEX) and International (IECEX)	Ex nA IIC T4 Gc

Safety and Hazardous Locations Standards

This product is designed to meet the requirements of the following electrical equipment safety standards for measurement, control, and laboratory use:

- IEC 61010-1, EN 61010-1
- UL 61010-1, CSA 61010-1
- EN 60079-0:2012, EN 60079-15:2010
- IEC 60079-0: Ed 6, IEC 60079-15; Ed 4
- UL 60079-0; Ed 6, UL 60079-15; Ed 4
- CSA 60079-0:2011, CSA 60079-15:2012

Note For UL and other safety certifications, refer to the product label or the [Online Product Certification](#) section.

Electromagnetic Compatibility

This product meets the requirements of the following EMC standards for electrical equipment for measurement, control, and laboratory use:

- EN 61326-1 (IEC 61326-1): Class A emissions; Industrial immunity
- EN 55011 (CISPR 11): Group 1, Class A emissions
- EN 55022 (CISPR 22): Class A emissions
- EN 55024 (CISPR 24): Immunity
- AS/NZS CISPR 11: Group 1, Class A emissions
- AS/NZS CISPR 22: Class A emissions
- FCC 47 CFR Part 15B: Class A emissions
- ICES-001: Class A emissions

Note In the United States (per FCC 47 CFR), Class A equipment is intended for use in commercial, light-industrial, and heavy-industrial locations. In Europe, Canada, Australia and New Zealand (per CISPR 11) Class A equipment is intended for use only in heavy-industrial locations.

Note Group 1 equipment (per CISPR 11) is any industrial, scientific, or medical equipment that does not intentionally generate radio frequency energy for the treatment of material or inspection/analysis purposes.

Note For EMC declarations and certifications, and additional information, refer to the [Online Product Certification](#) section.

CE Compliance

This product meets the essential requirements of applicable European Directives, as follows:

- 2014/35/EU; Low-Voltage Directive (safety)

- 2014/30/EU; Electromagnetic Compatibility Directive (EMC)
- 2014/34/EU; Potentially Explosive Atmospheres (ATEX)

Product Certifications and Declarations

Refer to the product Declaration of Conformity (DoC) for additional regulatory compliance information. To obtain product certifications and the DoC for NI products, visit ni.com/product-certifications, search by model number, and click the appropriate link.

Shock and Vibration

To meet these specifications, you must panel mount the system.

Operating vibration	
Random	5 g RMS, 10 Hz to 500 Hz
Sinusoidal	5 g, 10 Hz to 500 Hz
Operating shock	30 g, 11 ms half sine; 50 g, 3 ms half sine; 18 shocks at 6 orientations

Environmental

Refer to the manual for the chassis you are using for more information about meeting these specifications.

Operating temperature (IEC 60068-2-1, IEC 60068-2-2)	-40 °C to 70 °C
Storage temperature (IEC 60068-2-1, IEC 60068-2-2)	-40 °C to 85 °C
Ingress protection	IP40

Operating humidity (IEC 60068-2-30)	10% RH to 90% RH, noncondensing
Storage humidity (IEC 60068-2-30)	5% RH to 95% RH, noncondensing
Pollution Degree	2
Maximum altitude	5,000 m

Indoor use only.

Environmental Management

NI is committed to designing and manufacturing products in an environmentally responsible manner. NI recognizes that eliminating certain hazardous substances from our products is beneficial to the environment and to NI customers.

For additional environmental information, refer to the **Engineering a Healthy Planet** web page at ni.com/environment. This page contains the environmental regulations and directives with which NI complies, as well as other environmental information not included in this document.

EU and UK Customers

-  **Waste Electrical and Electronic Equipment (WEEE)**—At the end of the product life cycle, all NI products must be disposed of according to local laws and regulations. For more information about how to recycle NI products in your region, visit ni.com/environment/weee.

电子信息产品污染控制管理办法（中国 RoHS）

-  **中国 RoHS**— NI 符合中国电子信息产品中限制使用某些有害物质指令(RoHS)。关于 NI 中国 RoHS 合规性信息，请登录 ni.com/environment/

rohs_china. (For information about China RoHS compliance, go to ni.com/environment/rohs_china.)

Calibration

You can obtain the calibration certificate and information about calibration services for the NI-9232 at ni.com/calibration.

Calibration interval	1 year
----------------------	--------

¹ The DC + AC voltage must be below the overvoltage protection of the NI-9232.

² Refer to the software help for information on reading the IEPE fault detection status.

³ Range equals 31.5 V

⁴ DC coupled

⁵ Uncalibrated accuracy refers to the accuracy achieved when acquiring data in raw or unscaled modes and in which calibration constants that are stored in the module are not applied to the data.

⁶ For conformal coated version, the maximum flatness for 20 Hz to 20.48 kHz is 76 mdB.

⁷ For conformal coated version, the maximum flatness for 20 Hz to 40.96 kHz is 102 mdB.

⁸ Rejection of analog prefilter at oversample rate.