

製品仕様書/Product Specification	No.	IS-11501-006	来歴	0
	頁/Page	1/8		
標題 : 11501 シリーズ 0.5mmピッチ FPC/FFC コネクタ (NON-ZIF) SUBJECT : Series 11501 0.5mm Pitch FPC/FFC Connector(NON-ZIF)	制定年月日/ISSUED DATE	2015 - 6 - 23		
	改訂年月日/REVISED DATE			

1. 適用範囲

本仕様書は、イリソ電子工業株式会社製 11501 シリーズ 0.5mmピッチ FPC/FFC コネクタに関する仕様及び性能上の必要事項について規定する。  
(顧客名：車載系各社)

2. 構造及び寸法

構造、寸法、主要部品の材質、表面処理等は添付図による。  
適用ソケット：IMSA-11501S-\*\*\*-GFN1

3. 定格

- (1)最大定格電圧 50V (AC, DC)
- (2)最大定格電流 0.5A
- (3)使用温度範囲 -40~+105℃  
(通電による温度上昇含む)

4. 試験環境

特に規定のある場合を除き、性能試験は、下記の試験条件のもとで行う。

- 常温 15~35℃
- 常湿 25~85% (相対湿度)

5. 性能

5-1. 電気的性能

項目/Item	条件/Test condition	規格/Specification
1 接触抵抗 Contact Resistance	短絡電流 1mA、最大開放電圧 20mV、周波数 1kHz のローレベル抵抗計にて測定する。 It shall be measured by the dry electric circuit specified as follows; 1mA, 20mV, 1kHz frequency.	初期値：40mΩ以下 各試験後：80mΩ以下 Initial: 40mΩ or below. After each test: 80mΩ or below.
2 耐電圧 Dielectric Withstanding Voltage	隣接する極間に AC250V を 1 分間印加する。 AC 250V shall be applied for one minute to between next terminals.	絶縁破壊等異常のない事。 Should not have any changes.
3 絶縁抵抗 Insulation resistance	隣接する極間に DC500V を印加する。 DC 500V shall be applied to between next terminals.	初期値：50MΩ以上 耐湿試験後：50MΩ以上 Initial: 50MΩ or more After humidity test: 50MΩ or more
4 外観 Appearance	目視 Visual	有害となる割れ、剥がれ、ガタ変形、変色のない事。 Should not have any flaw, scratch, discoloration, and crushed.

5-2. 機械的特性

5-2. Functional Performance

項目/Item	条件/Test condition	規格/Specification
1 端子の保持力 Contact retention force	端子に 25mm/分の速度で加重を加え、端子がハウジングより抜け始めたときの荷重を測定する。 The contact shall be pulled at the speed of 25mm per minute and measured the force when the contact begins to remove from the housing.	1.0N 以上 1.0N or more
2 挿抜耐久性 Insertion /Extraction endurance	FFC を 20 回繰返し挿抜を行ない接触抵抗を測定する。 The FFC shall be mated and unmated 20 times and measured the contact resistance.	80mΩ 以下 80mΩ or below
3 衝撃試験 Shock test	FFC を嵌合した状態にて治具に取り付け、加速度 980m/s <sup>2</sup> 、衝撃作用時間 6ms を X,Y,Z,方向の 6 面に各 10 回加え、試験中の瞬断の有無の確認、試験後の接触抵抗の測定及び外観観察する。 The connector and FFC mated are installed in the machine. They are applied pulses 10 times to each 6 faces of 3 mutually perpendicular directions(X,Y,Z); under conditions as specified ; acceleration of 980m/s <sup>2</sup> and shock pulses for a duration of 6ms . It shall be tested the discontinuity of the contact current during the test and measured the contact resistance and observed its appearance after the test.	試験中 1 μs 以上の瞬断の無き事。 80mΩ 以下 外観：異常なきこと Discontinuity : 1 μs or less. 80mΩ or below . Should not have any damages

1. Scope

This product specification is applied to IRISO ELECTRONICS CO.,LTD. Series 11501 0.5mm Pitch FPC/FFC Connector.  
(CUSTOMER NAME : AUTOMOTIVE EACH COMPANY)

2. Configuration, dimensions and materials

See the product drawing attached.  
Applied for socket : IMSA-11501S-\*\*\*-GFN1

3. Rating

- (1) Maximum rating voltage: 50 V (AC, DC)
- (2) Maximum rating current: 0.5A
- (3)Temperature range : -40~+105℃  
(Rise in heat is included)

4. Performances

All performance tests, unless otherwise specified, are taken under following environmental conditions.

- Ambient temperature : 15~35℃
- Ambient humidity :25~85%RH

5. Performance

5-1.Electrical performance

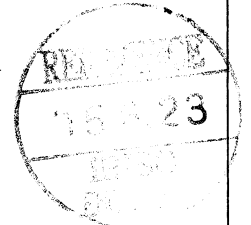

4	振動試験 Vibration test	FFCを嵌合した状態にて、振動周波数10~500~10Hz、掃引時間12分、振幅1.5mm、又は加速度98m/s <sup>2</sup> のいずれか小さい方にてX軸方向に4時間、YZ軸方向に各2時間計8時間の振動を加える。試験中、瞬断の有無の確認、試験後の接触抵抗の測定及び外観観察をする。 The connector and FFC mated is vibrated in the frequency range of 10~500~10Hz/12min and in the constant vibration amplitude 1.5mm or the acceleration of 98m/s <sup>2</sup> . The amplitude or the acceleration above shall be chosen either one under which the connectors is loaded more slightly. And this motion is applied for period of 4hours in one of 3 mutually perpendicular directions(X-axis), and 2hours in other two of them(Y and Z-axis). It shall be tested the discontinuity of the contact current during the test and measured the contact resistance and observed its appearance after the test.	試験中1μs以上の瞬断の無き事。 80mΩ以下 外観：異常なきこと Discontinuity: 1μs or less. 80mΩ or below. Should not have any damages
5	FFC挿抜力 FFC Insertion /Extraction force	コネクタとFFCを25mm/分の速度で挿入を行い、この時の荷重を測定する。(初回) The connector and FFC shall be mated at the speed of 25mm per minute and measured the force of insertion. (First time)	挿入力：0.625N/極 以下 Insertion force : 0.625N/ckt or below
6	FFC保持力 FFC retention force	FFCに25mm/分の速度で加重を加え、FFCがハウジングより抜け始めたときの荷重を測定する。 The FFC shall be pulled at the speed of 25mm per minute and measured the force when the FFC begins to remove from the housing.	0.29N/極 以上 0.29N/ckt or more

5-3. 環境特性

5-3.Environmental performance

項目/Item	条件/Test condition	規格/Specification
1 耐熱性 Heat resistance	FFCを嵌合した状態にて温度105±2℃の恒温槽に1000時間放置し、試験後接触抵抗測定及び外観観察を行う。 The connector and FFC mated is exposed in the heat chamber 105±2℃ for 1000 hours. It shall be measured the contact resistance and observed its appearance after the test.	80mΩ以下 外観：異常なきこと 80mΩ or below. Should not have any damages
2 耐寒性 Chilly resistance	FFCを嵌合した状態にて温度-40±3℃の低温槽に1000時間放置し、試験後接触抵抗測定及び外観観察を行う。 The connector and FFC mated is exposed in the chilly chamber -40±3℃ for 1000 hours. It shall be measured the contact resistance and observed its appearance after the test.	80mΩ以下 外観：異常なきこと 80mΩ or below. Should not have any damages
3 耐湿性 Humidity	FFCを嵌合した状態にて温度85±2℃、相対湿度85%の恒温恒湿槽に1000時間放置し、試験後接触抵抗測定及び外観観察を行う。 The connector and FFC mated is exposed in the heat chamber 85±2℃,85%RH for 1000 hours. It shall be measured the contact resistance and observed its appearance after the test.	80mΩ以下 外観：異常なきこと 80mΩ or below. Should not have any damages
4 H <sub>2</sub> Sガス試験 H <sub>2</sub> S gas test	FFCを嵌合した状態にて、温度40±2℃、相対湿度75%、濃度3±1ppmの雰囲気中に96時間放置し、試験後接触抵抗を測定する。 The connector and FFC mated is exposed in the H <sub>2</sub> S gas chamber 40±2℃,75% RH 3±1ppm for 96 hours. It shall be measured the contact resistance after the test.	80mΩ以下 外観：異常なきこと 80mΩ or below. Should not have any damages
5 SO <sub>2</sub> ガス試験 SO <sub>2</sub> gas test	FFCを嵌合した状態にて、温度40±2℃、相対湿度75%、濃度10±3ppmの雰囲気中に96時間放置し、試験後接触抵抗を測定する。 The connector and FFC mated is exposed in the SO <sub>2</sub> gas chamber 40±2℃,75% RH 10±3ppm for 96 hours. It shall be measured the contact resistance after the test.	80mΩ以下 外観：異常なきこと 80mΩ or below. Should not have any damages
6 塩水噴霧試験 Salt spray test	FFCを嵌合した状態にて、温度35±2℃、濃度5±1%の塩水噴霧中に48時間放置し、試験後接触抵抗を測定する。 The connector and FFC mated is exposed in the salt spray chamber 35±2℃,5±1% salt density for 48 hours. It shall be measured the contact resistance after the test.	80mΩ以下 外観：異常なきこと 80mΩ or below. Should not have any damages

項目/Item	条件/Test condition	規格/Specification
7 冷熱衝撃試験 Thermal shock test	<p>FFC を嵌合した状態にて下図の温度条件を 1 サイクルとして 1000 サイクル実施し、試験後接触抵抗測定及び外観観察を行う。 The connector and FFC mated is exposed 1000 cycles under the following temperature conditions. It shall be measured the contact resistance and observed its appearance after the test.</p>	<p>80mΩ以下 外観：異常なきこと 80mΩ or below . Should not have any damages</p>
8 温湿度 サイクル試験 Humidity resistance	<p>FFC を嵌合した状態にて下図の温度条件を 1 サイクルとして 10 サイクル実施し、試験後接触抵抗測定及び外観観察を行う。 The connector and FFC mated is exposed 10 cycles under the following temperature conditions. It shall be measured the contact resistance and observed its appearance after the test.</p>	<p>80mΩ以下 外観：異常なきこと 80mΩ or below . Should not have any damages</p>

5-4. その他の性能

5-4.Other specification

項目/Item	条件/Test condition	規格/Specification
1 半田付け性 Solderability	<p>コネクタの半田付け部をフラックスに浸漬した後、245±5°Cの Sn-Ag-Cu 系の鉛フリー半田槽に 3±0.5 秒浸す。 The terminal of connector shall be put into the flux and dipped into Pb free solder bath (Type of Sn-Ag-Cu) 245±5°C,3±0.5s .</p>	<p>浸した面積の 95%以上に半田がむらなく付着する事。 Solder shall cover 95% or more of the area that is dipped into the solder bath.</p>
2 半田耐熱性 Soldering heat test	<p>下記条件にて、半田耐熱試験を行う。 The connector shall be tested resistance to soldering heat under the following conditions. 条件①：リフローの場合 (2 回) / In case of reflow (2 times) 250°C MAX. (ピーク温度)、10s MAX. (Peak temperature)</p> <p>(予熱 150~180°C) (pre-heat : from 150 to 180°C) 温度は製品上面の温度とする。 The temperature shall be measured on the surface of the product. (2)手半田の場合/ In case of manual soldering. 半田鍍温度 / temperature : 350±5°C 浸漬時間 / time : 3±0.5s 但し、ピンに異常加圧無き事。 /However, excessive pressure shall not be applied to the terminal.</p>	<p>実使用上、問題無き事。 Should not have any problems.</p>
3 温度上昇試験 Rise of temperature test	<p>最大許容電流を通电し、熱電対法にてコネクタの温度上昇を測定する。 The connector shall be operated in the maximum rise of current and measured rise of the temperature at contact point.</p>	<p>温度上昇：30°C以下 Rise of temperature : 30°C or below</p>

6.その他

- ・改良等によりひけ逃げを追加する事がありますので、ご了承願います。
- ・和文と英文の内容に差異が生じた場合には、和文の内容を優先致します。
- ・本製品は、錫系のめっきを施しておりますので、ウィスカーが発生する可能性がございます。その為、ウィスカー発生に対する保証は困難であり、御社にて御判断の上御使用をお願いします。

6. Others

Please acknowledge adding shape to lose sink by the improvement etc.

When difference is found between Japanese Specifications and English Specifications, priority shall be given to Japanese.

This product utilizes lead-free tin plating. Any product with lead-free tin plating is susceptible to tin whisker. Iriso provides no assurances against the growth of tin whisker even under normal operating conditions. Customers assume all responsibility for any product failures due solely to the growth of tin whiskers.

7.故障率

MIL-HDBK-217D,2-11,2 プリント配線板コネクタに基づいて算出を行う。(単位：FIT)

7.Failure rate

Failure rate shall be calculated as MIL-HDBK-217D,2-11,2 (Unit : FIT)

極数/ckt	故障率/Failure rate
20	2.03
25	2.42
30	2.84
35	3.28
40	3.76
45	4.27
50	4.82
55	5.40
60	6.03

8. 製品の保管期間

納入日より1年とする。

8. Term of a guarantee

1 year from delivery date.

9.保管条件

温度-10~+40℃、湿度75%RH以下の相対湿度で保管してください。

9.Storage condition

Shall be storage in the house at -10~+40℃,75%RH MAX.

# FPC/FFC 用コネクタ

Connector for FPC/FFC

取り扱い説明書

Manual

適用製品：11501 シリーズ

Application product: series 11501

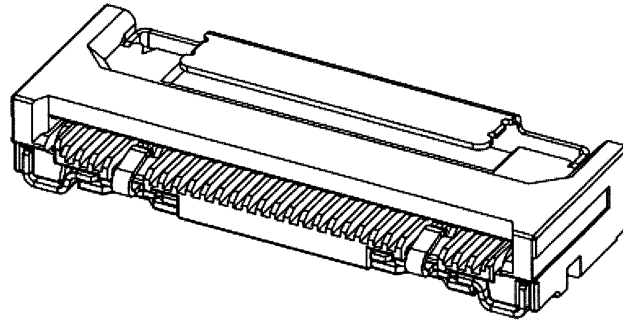

### 操作方法

#### FPC/FFC 挿入方法 FPC/FFC insertion

- ① FPC/FFC は導体面を下にして挿入してください。  
 その際 FPC/FFC はコネクタに対し垂直に挿入口へ奥に突き当たるまでしっかり挿入してください。  
 Fully insert the FPC/FFC parallel to mounting surface, with the exposed conductive traces facing DOWN.

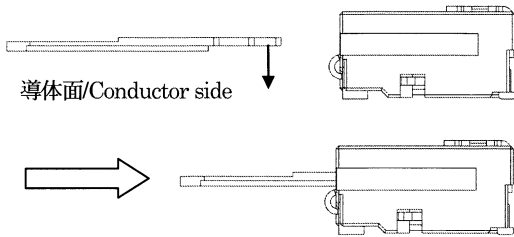

- ② FPC/FFC はコジらず、真直ぐ挿入してください。  
 Please insert FPC/FFC straight.

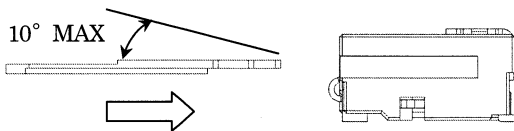
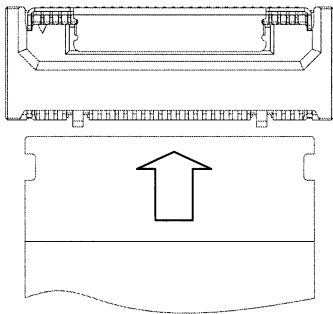

#### FPC/FF

#### C 抜去方法 FPC/FFC removal

- ① 上面の解除レバーを押しながら、FFC/FPC を引き抜いてください。  
 While holding down the top of the release lever, the FFC / FPC pull out.

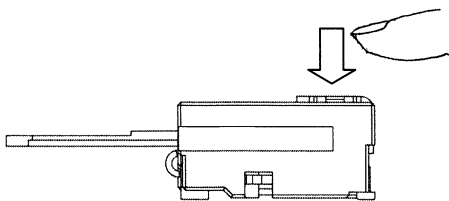

### 使用上の注意点

斜めに挿入したり、こじって挿入しますと、半嵌合又は、接点へのダメージの原因となり、接触不良が発生する恐れがございます。  
 The terminal transformation happens when FPC/FFC is diagonally inserted.  
 And, the loose connection happens.

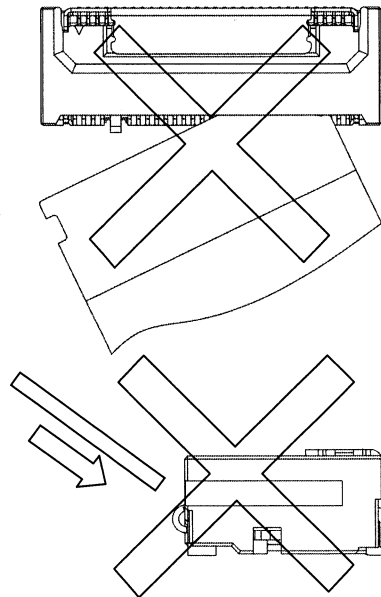

解除レバーを押さずに FFC/FPC を引き抜きますと、コネクタもしくは FFC/FPC が破損する可能性がございます。  
 When you pull the FFC / FPC without pressing the release lever, connector or FFC / FPC will be damaged.

解除レバーは軽い力で押し下がりますので、強い力を加えないでください。(10N 以下)

Release lever is not pressed strongly.(10N MAX.)

②FFC/FPC はコジらず、真直ぐ引き抜いてください。  
Please pull out FFC/FPC straight.

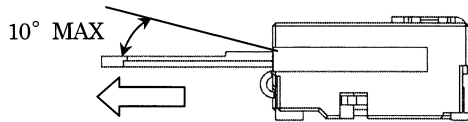
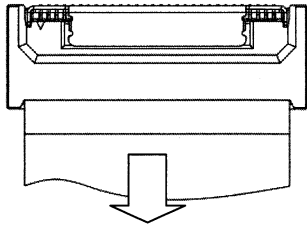

FFC/FPC 嵌合状態 FFC/FPC mating

①FFC/FPC 嵌合状態で上方方向にテンションが掛からないようにしてください。

The force of FFC / FPC is to not placed on the top.

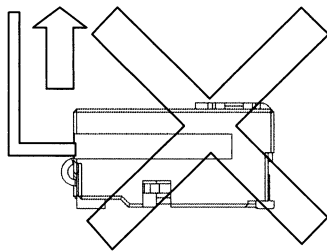

②FFC/FPC の引き回しがコネクタ上面に来ないようにしてください。

解除レバー操作が困難になります。

FFC / FPC is to avoid incurring the connector top.

Release lever operation becomes difficult.

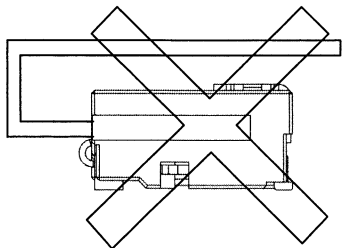

その他 Others

①コネクタ実装後、半田接合部が変色する場合がございますが  
使用上問題ございません。

There is no problem in use though the solder joint part might  
discolor after mounting the connector.

②モールド内に黒点が発生する場合がございますが、性能上  
問題ございません。

There is no problem on the performance though the black spot  
might be generated in molding.

③異種金属嵌合は、行わないでください。

Please do not do the different kind metal mating.

④カード挿入口前に、カードの姿勢が変わるような部品を  
配置しないでください。

Please do not arrange parts into which the posture of the card  
changes in the card insertion entrance front.

⑤反転リフロー時に製品が落下する可能性がございますので  
テープ等で補強することを推奨致します。

Since a product may fall at the time of reversal reflow,  
I recommend reinforcing on a tape etc.

⑥FFC/FPCを挿抜する際は、補強板を持って行ってください。

FFC / FPC to operate with a reinforcing plate.

⑦活線挿抜は行わないでください。

Please do not hot-swap.