

AI-in-Sensor Imager with Low Power Bluetooth/Wifi, ARM Cortex M3, Crypto Engine, Power Management and More

General description

MantisConnect is an “always on,” Ai-in-Imager solution for IoT applications in busy areas where IR triggered cameras have a short battery life, or where IR beam sensors or ultrasound detectors have traditionally been used. MantisConnect is designed to minimize development time, area and power for rapid real-world deployment. MantisConnect includes a CIS imager, inference AI engine, AEC (automatic exposure control), power management (including on board DC/DC), timing control, an ARM Cortex M3 microcontroller, ultra low power Bluetooth & Wifi, a crypto engine, 8 Mbits of Flash memory, real time clock, and decoupling capacitor. The only external parts required are a lens, crystal oscillators and antenna components.

MantisConnect is a “code zero” device offering AI network building blocks which may be combined to build arbitrary AI solutions. A number of pre-existing AI solutions may be downloaded from the AISTorm website for rapid deployment.

MantisConnect is available in a 8.6x5x1.1mm 66 pin OLGA package.

Diagram

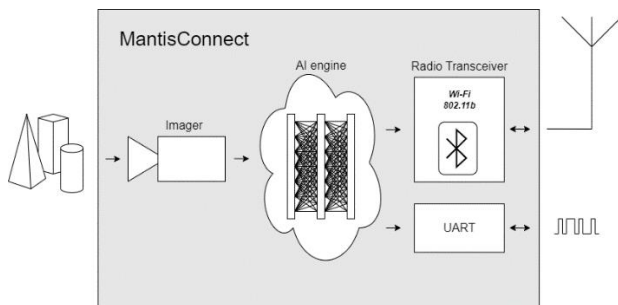

Figure 1 – MantisConnect Concept



Figure 2 – Relative Size of MantisConnect

Features

- **Complete AI-in-Sensor Single Part Sol'n:**
 - 96x96 CMOS Image Sensor Array
 - Inference AI Engine
 - ARM Cortex M3 with 8Mbits Flash
 - Wireless Radio Transceiver
 - AEC (automatic exposure control)
 - Power Management
 - Low-power Always On Operation (~1mA)
 - **Ultra Low Power Wifi**
 - 802.11b up to 11Mb
 - Supports STA Mode
 - WPA/WPA2 security supported
 - Automatic beacon scanning and discover
 - Built in TCP/IP Stack
 - Integrated Dual PAs (-2dBm and +10dBm)
 - **Bluetooth Smart**
 - Compliant with BLE 5.0 BLE up to 2Mbps
 - Slave Mode Support
 - All GATT-based Profiles Supported
 - Built in BLE Stack
 - 0 to 10dBm Output Power
 - -93dBm Receive Sensitivity
 - **HW Crypto Engine**
 - AES128/256 Operation
 - P-192/256 ECDH (Elliptic Curve Diffie-Hellman) Key Generation
 - **Integrated power management including DC/DC**
 - **Real time clock, UART, OTA Firmware Update**
 - **8.6x5x1.1mm, 66 pad, optical land grid array (OLGA)**
- ### Applications
- Face classification/detection
 - IR & Ultrasound Sensor Replacement
 - Smart Occupancy Sensors for Home and Business Automation
 - People counting (virtual barrier)
 - Gesture identification
 - Person Detection
 - Smart Locks, Smart Lighting
 - Smart Parking
 - Retail Analytics and Theft Prevention
 - Smart Coffee Makers
 - Camera to Camera Person Tracking
 - Proximity Detection

1 General Description

MantisConnect is a single component AI-in-Imager chip easing the development of optical IoT systems relying upon AI inference processing of optical images. MantisConnect includes all components required to implement a Smart Imager solution other than antenna components, oscillators, external LEDs and decoupling capacitors. As such it can create a uniquely small, low profile, low power solution.

In always-on mode, MantisConnect draws ~1mA, maximizing operating time on small batteries. Simply connect the two oscillators and decoupling capacitors to the power inputs and the device is operational with all functions required to implement an IoT always-on monitoring system. It can be used in a modular fashion with AISTorm’s Cheetah or Chameleon products which can offer real time face or muscle based biometric identification.

1.1 Imager



Gesture Recognition

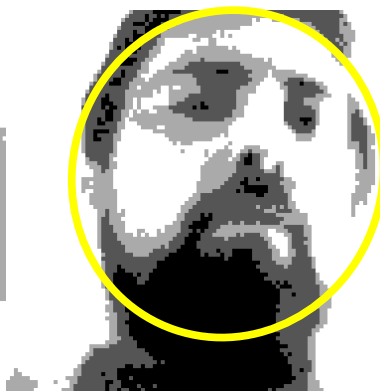

Face Detect



Hands Detect



Product Added to Grocery Cart



Shopper with Grocery Car



People Tracking in Office



Parking Place Full

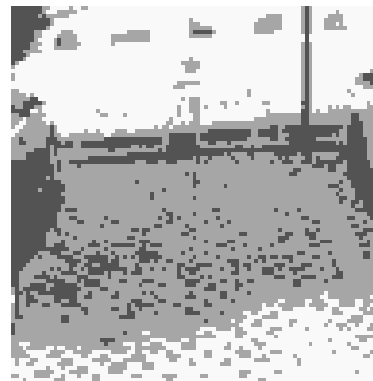

Parking Place Empty

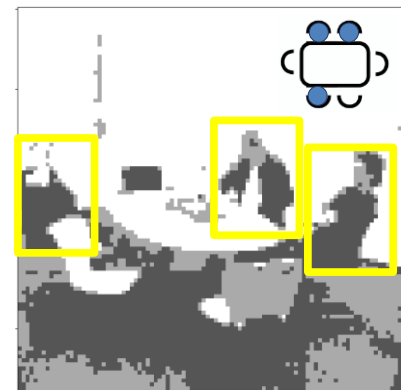

Conference Room Usage

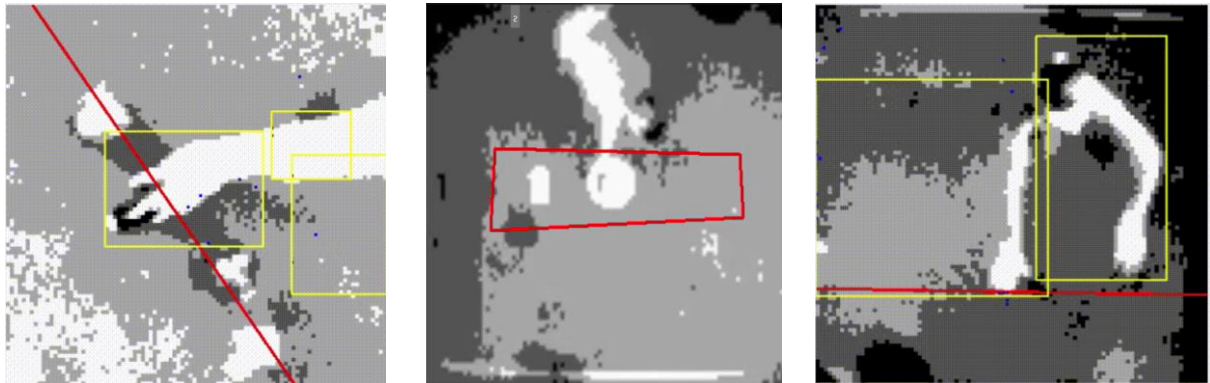

Hand in Display Case

Virtual Barrier Intrusion

Direction, Arms, Hands Monitoring

Figure 3 – Example 96x96 Video from MantisConnect

1.2 General Description

MantisConnect offers a 96x96 2-bit imager. This is sufficient for most IoT applications including face detect, person detect, tracking, proximity detection, animal versus person, smart home and smart retail applications, smart lighting, etc. The 96x96 helps reduce system power and is meant as an improvement over PIR or ultrasonic sensors. MantisConnect is not meant to replace high resolution imagers available on much more expensive systems and should be used in appropriate applications where the benefit of replacing one or a few pixels with 9,120 pixels to improve functionality is important.

The SPI interface may be used to upload or download images or videos to perform ISP externally or to perform inference on images from other image sensors using MantisConnect.

1.3 Automatic Exposure Control (AEC)

Automatic exposure control is an important feature of MantisConnect. To enable AEC there are multiple automatic modes that help to ensure and distribute the four thresholds to obtain the best image. It is important to note that the AEC can only work in conjunction with focused optics and therefore it is important that the optics are carefully tuned to the focal point. The AEC system also allows manual overrides to adjust performance based on custom settings.

MantisConnect comes with easily parametrizable AIS proprietary optimized AEC functions. See Datasheet for more information.

2 Machine Learning Inference

2.1 Inference Primitives

Instruction Name	Description	Input	Output
[REDACTED]	[REDACTED]	[REDACTED]	[REDACTED]
[REDACTED]	[REDACTED]	[REDACTED]	[REDACTED]
[REDACTED]	[REDACTED]	[REDACTED]	[REDACTED]

[Redacted]	[Redacted]	[Redacted]	[Redacted]
[Redacted]	[Redacted]	[Redacted]	[Redacted]
[Redacted]	[Redacted]	[Redacted]	[Redacted]
[Redacted]	[Redacted]	[Redacted]	[Redacted]
[Redacted]	[Redacted]	[Redacted]	[Redacted]
[Redacted]	[Redacted]	[Redacted]	[Redacted]
[Redacted]	[Redacted]	[Redacted]	[Redacted]
[Redacted]	[Redacted]	[Redacted]	[Redacted]
[Redacted]	[Redacted]	[Redacted]	[Redacted]
[Redacted]	[Redacted]	[Redacted]	[Redacted]
[Redacted]	[Redacted]	[Redacted]	[Redacted]
[Redacted]	[Redacted]	[Redacted]	[Redacted]
[Redacted]	[Redacted]	[Redacted]	[Redacted]
[Redacted]	[Redacted]	[Redacted]	[Redacted]
[Redacted]	[Redacted]	[Redacted]	[Redacted]
[Redacted]	[Redacted]	[Redacted]	[Redacted]
[Redacted]	[Redacted]	[Redacted]	[Redacted]
[Redacted]	[Redacted]	[Redacted]	[Redacted]
[Redacted]	[Redacted]	[Redacted]	[Redacted]
New Primitives will be added regularly...			

Table 1 – MantisNet Built in Instruction Set

MantisConnect utilizes a “code-zero” limited instruction set further detailed in Table 1 above. To simplify development MantisConnect inference models are meant to be built out of these instructions and custom applications are not supported if they are built out of other primitives. If an additional primitive is required AISTorm is willing to develop it on a custom basis. MantisConnect primitives include CNN and fully connected layers with scalable input and output fanouts allowing them to be stacked to create deep networks. MantisConnect utilizes one of: i) a ternary weights; ii) binary weights or and; iii) four bit data to minimize power consumption. The hardware platform is optimized for high efficiency calculations utilizing these types of networks.

Additionally, MantisConnect provides functional support for binary and 4 bit layers. Example networks include but are not limited to:

- Face Detection/Classification
- Gesture Recognition
- Hand classifier
- Hand motion tracking
- Parcel Detection
- People Detection (with virtually defined barriers)
- People Counting (with virtually defined barriers)
- People Tracking (includes camera to camera)

Subject to change without notice.

- Car presence detection (parking)

These can be downloaded from the AISTorm's Git repository web site.

MantisConnect is programmed using a TensorFlow Lite based develop system which includes modified python files to consider the part to part charge domain variations. ISP functionality can be performed using the ARM Cortex M3.

2.2 Training

The primitives in Table 1 represent the basic building blocks of many standard neural network topologies. Many popular topologies may be translated into this format with similar results to the original. MantisConnect is not meant to be programmable such that it utilizes instructions other than those in Table 1.

Training can be performed using TensorFlow Lite with modified python scripts available from the Git repository after upon execution of an NDA and Support Agreement. Note that MantisConnect is a continuous, not discretized system and therefore the notion of bits is meant only as a worst case INL fit to an ideal ADC line. The development system includes accuracy settings that are meant to help consider the part to part variations of MantisConnect and determine the system accuracy considering these variations. The user can work with the tools to help optimize the final accuracies over multiple devices according to the training data.

2.3 Always-On Power

To achieve minimum power the LEDs need to be off, interfaces off, and the DC/DC configuration used rather than using the LDO configuration. In this circumstance the system will operate with [REDACTED] from 1.6V without any RF connection [REDACTED] with a consistent RF connection. This assumes a frame rate of 1fps and an algorithm such as face detection. Simpler models or slower frame rates will reduce the power further.

2.4 Crypto Engine

MantisConnect includes a powerful secure subsystem and crypto engine including AES128/256 and P-192/256 ECDH (Elliptic Curve Diffie-Hellman) Key Generation. This can be used to protect sensitive information in real world applications.

3 Electrical Information

3.1 Electrical Block Diagram

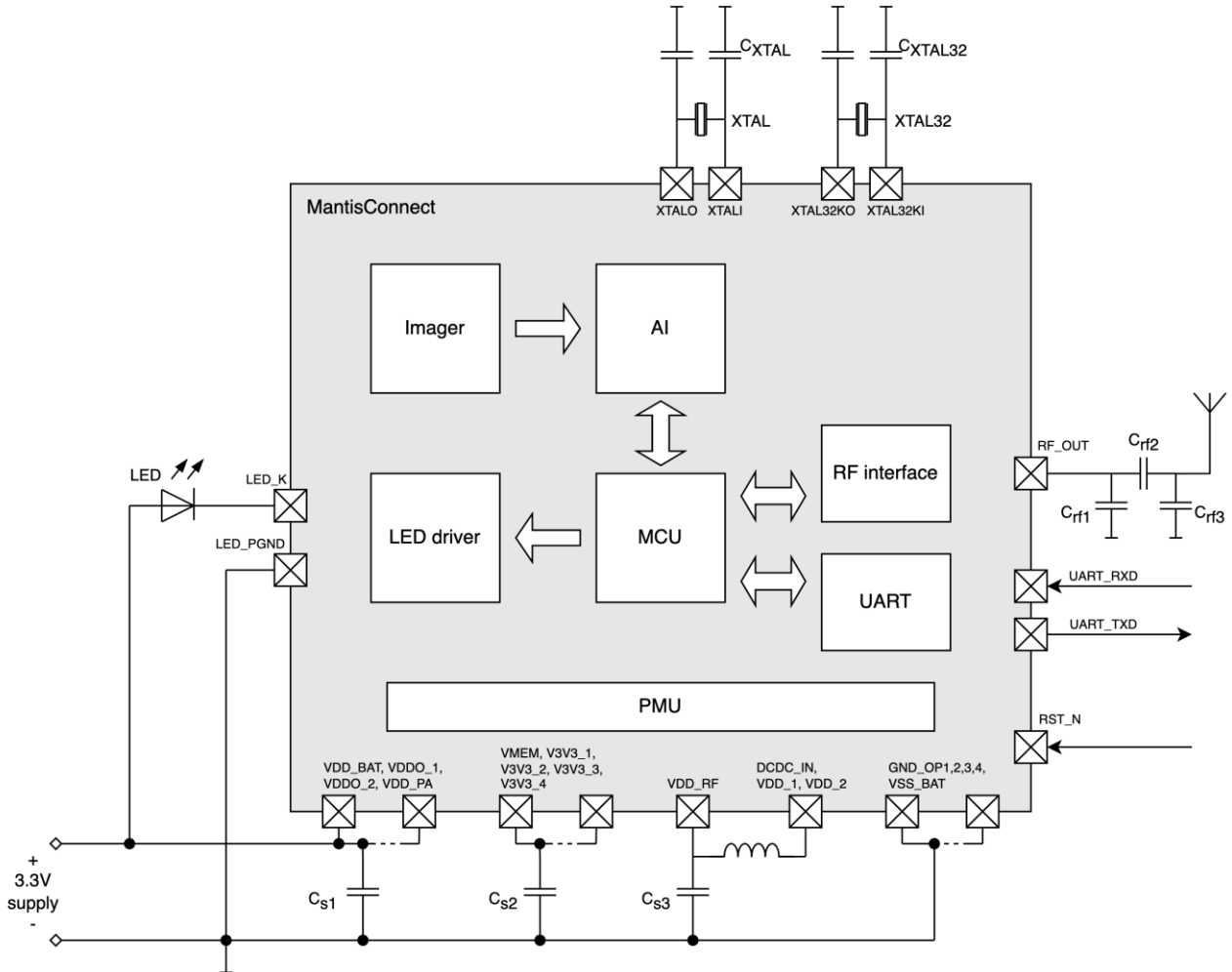

Figure 4 Electrical Connection Block Diagram

4 Pin list

Pin number	Pin name	Voltage rating	Type	Description
1				
2				
3				
4				
5				
6				
7				
8				
9				

Subject to change without notice.

6 Demo Board

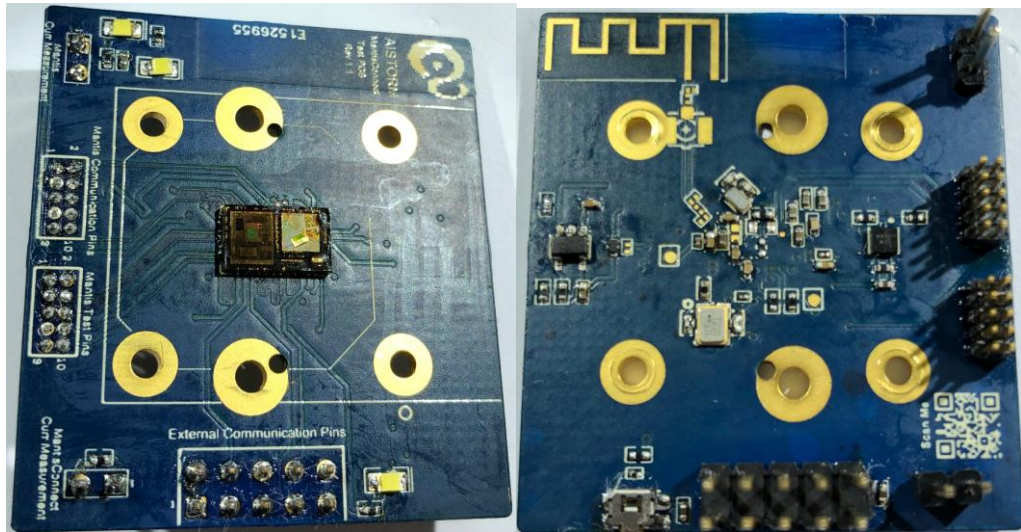

**Figure 7 MantisConnect Demo Board with PCB Antenna
(Large Holes are for Lens Mount)**

The MantisConnect Demo board includes all the components required to evaluate Mantis. This includes the MantisConnect chip itself, oscillators, antenna and antenna components, decoupling capacitors, connectors and mounting holes for a lens. For further information please refer to the MantisConnect Evaluation Board Demo Kit instructions.