

LED Driver for HiLOM

Outdoor 96 W Programmable

SL-LU2129601WW



High Efficiency Constant Current LED Driver With Active Power Factor Correction



Features & Benefits

- Output current range: 140 - 2100mA (Adjustable through programming tool)
- Output voltage range: 24 - 69 Vdc
- Output power range: Max. 96 W
- Dimming control: 0 - 10 Vdc / 10V PWM
- Input voltage: 100 - 277 Vac, 50 / 60 Hz
- Safety: UL 8750, CAN/CSA-C22.2 No.250.13-17
- EMI: FCC Part 15 ANSI C63.4 Class B
- Protections: Over Voltage, Short Circuit, Over Temperature
- t_c range: -40 ~ +88 °C
- Expected lifetime: 100,000 hrs @ $t_c=70^{\circ}\text{C}$, 80% Load
- Environmental compliance: RoHS
- Long lasting & high reliability
- Metal housing
- Type HL for use in a Class I , Division2 hazardous(Classified) location
- Completion of matching review with Samsung HiLOM module

Applications

- LED Street Lighting
- Outdoor LED Lighting
- High-bay Lighting

Table of Contents

1.	Characteristics	-----	3
2.	Safety standards	-----	5
3.	Typical Characteristics Graphs	-----	6
4.	Output Current Setting Process	-----	7
5.	Dimming	-----	8
6.	Reliability	-----	9
7.	Outline Drawing & Dimension	-----	10
8.	Label Structure	-----	11
9.	Packing Structure	-----	11
10.	Precautions in Handling & Use	-----	11
11.	Installation guide	-----	12

1. Characteristics

Article	Symbol	Specification			Unit	Note	
		Min.	Typ.	Max.			
INPUT SPECIFICATIONS							
Nominal voltage	Vin	100 ~ 277			Vac	127~300 Vdc	
Voltage range		90		305			
Nominal frequency	fin	50 / 60			Hz		
Frequency range		47		63			
Input current	Vin=120 Vac	lin			A	Measured at 100% Load	
	Vin=220 Vac			0.95			
Total harmonic distortion	THD			20	%	At Vin=100~277Vac,50/60Hz, 70~100% Load(67~96W)	
Power factor	PF	0.9			-		
Efficiency	Iset=1400mA	η	86.5	88.5		At Vin=120Vac, 100% Load, ta=25°C*	
	Iset=2100mA		87.0	89.0			
	Iset=1400mA	η	88.5	90.5		At Vin=220Vac, 100% Load, ta=25°C*	
	Iset=2100mA		89.0	91.0			
	Iset=1400mA		89.0	91.0			
	Iset=2100mA		89.0	91.0			
In-rush current(I ² t)	Vin=277 Vac			2	A ² s	ta=25°C, duration=392us	
OUTPUT SPECIFICATIONS							
Output voltage	Iset<1400mA	Vo	24	69	Vdc	Allowed operating voltage. Go to page.6 and see a) Operating window. Good performance area to meet PF>0.9 and THD<20%	
	Iset=1400mA		48	69			
	Iset=2100mA		32	46			
Peak voltage	Vp			89	Vdc	Open circuit, No-load protection	
Output current setting range	I _o set	140			2100	mA	±5%I _o set, Adjustable through programming tool
Output current setting range for constant power	Iset	1400			2100		
Default output current	I _{def}			2100			±5%I _{def}
Total output current ripple(pk-pk)	I _{ripple}			10%I _o max			100% Load. 20MHz BW
Output current ripple at <200Hz(pk-pk)				2%I _o max			100% Load.
Startup overshoot current	I _p			10%I _o max			100% Load

Article	Symbol	Specification			Unit	Note
		Min.	Typ.	Max.		
OUTPUT SPECIFICATIONS						
Output power	Po			96	W	
Line regulation		-5		5	%	100% Load
Load regulation		-5		5	%	
Turn-on delay time	td			1.0	s	Measured at 120Vac input, 70%~100% Load
				0.5		Measured at 220Vac input, 70%~100% Load
Temperature coefficient of loiset			0.06%/°C			Case temperature=0°C ~ tc max
DIMMING SPECIFICATIONS						
Absolute maximum voltage on the Vdim(+) pin		-20		20	Vdc	
Source current on the Vdim(+) pin		200	300	450	uA	Vdim(+)=0V
Recommended dimming range for 0-10V		0		10	Vdc	
PWM_in high level			10		Vdc	
PWM_in low level			0		Vdc	
PWM_in frequency range		200		2K	Hz	
PWM_in duty cycle		0		100	%	
Dimming output range		10%loiset		loiset	mA	1400mA ≤ loiset ≤ 2100mA
		140		loiset		140mA ≤ loiset < 1400mA
ENVIRONMENTAL SPECIFICATIONS						
Case temperature for safety	tc_s	-40		88		
Case temperature for warranty	tc_w	-40		75	°C	Measured at tc point as indicated on the product label
Storage temperature	ts	-40		85		Cool down before operating
Relative humidity		5		100	%	
IP rating			67		-	Suitable for outdoor environment
Expected lifetime	Vin=220 Vac		100,000		hrs	tc=70°C, 80% Load
MTBF	Vin=220 Vac		380,000			ta=25°C, 80% Load(MIL-HDBK-217F)
Dimensions	L x W x H		7.17 x 2.66 x 1.44		inch	
			182 x 67.5 x 36.5		mm	
Net weight			850		g	

2. Safety Standards

Safety standard	Description
UL 8750. CAN/CSA-C22.2 No.250.13-17	UL/cUL Safety
FCC Part 15, ANSI C63.4 Class B	Conducted and Radiated Emission Test
IEC/EN 61000-3-2	Harmonic current emission : Class C
IEC/EN 61000-3-3	Voltage fluctuations and flicker
IEC/EN 61000-4-2	Electrostatic discharge(ESD) : 8kV air discharge, 4kV contact discharge
IEC/EN 61000-4-3	Radio-frequency electromagnetic field susceptibility test-RS
IEC/EN 61000-4-4	Electrical fast transient(EFT)/Burst
IEC/EN 61000-4-5	Surge immunity test : L-L 6kV, L-FG 10kV
IEC/EN 61000-4-6	Conducted radio frequency disturbances test-CS
IEC/EN 61000-4-8	Power frequency magnetic field test
IEC/EN 61000-4-11	Voltage dips and short interruptions

3. Typical Characteristics Graphs

a) Operating Window

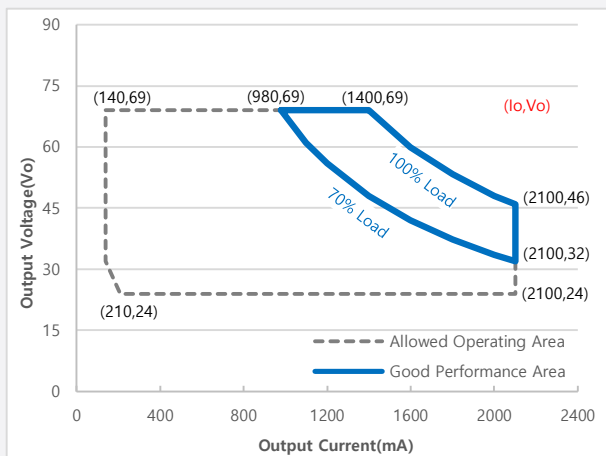

b) Efficiency vs. Load (Iset=2100mA)

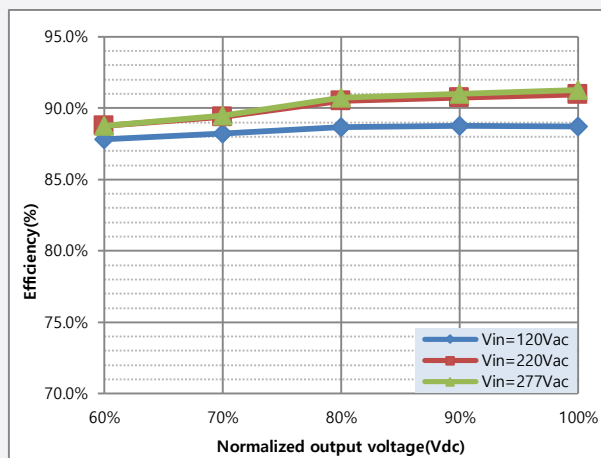

c) PF vs. Load

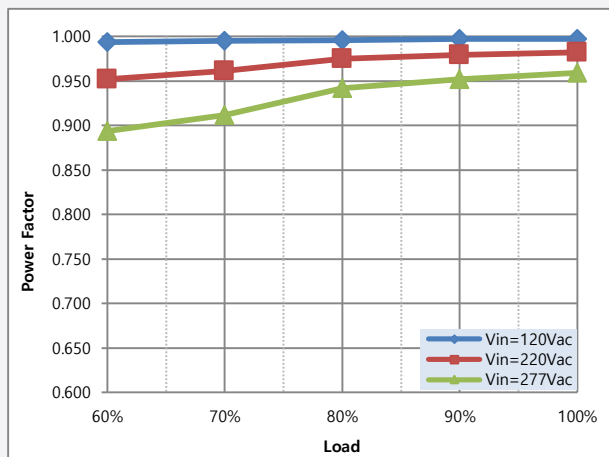

d) THD vs. Load

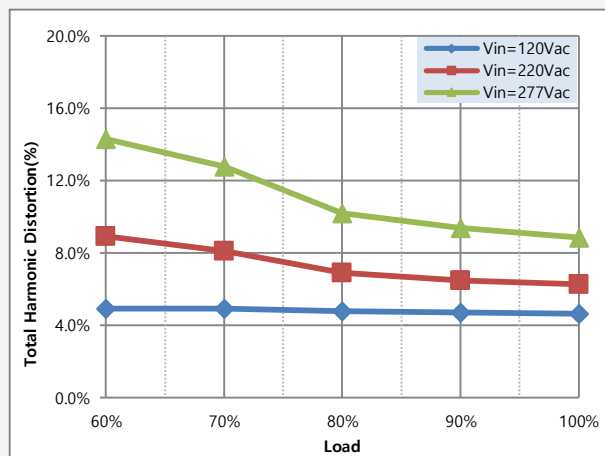

e) Derating

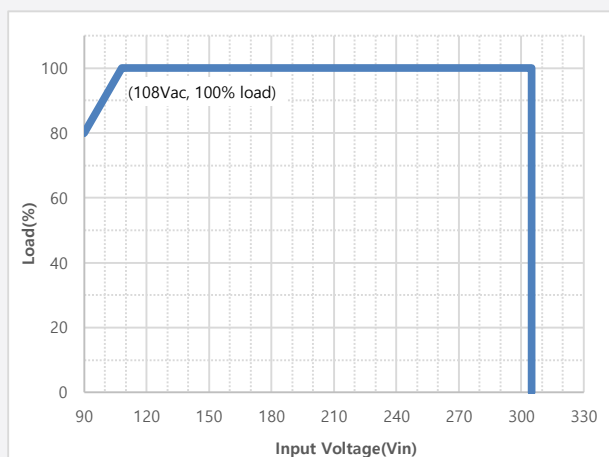

f) Lifetime vs. Case temperature

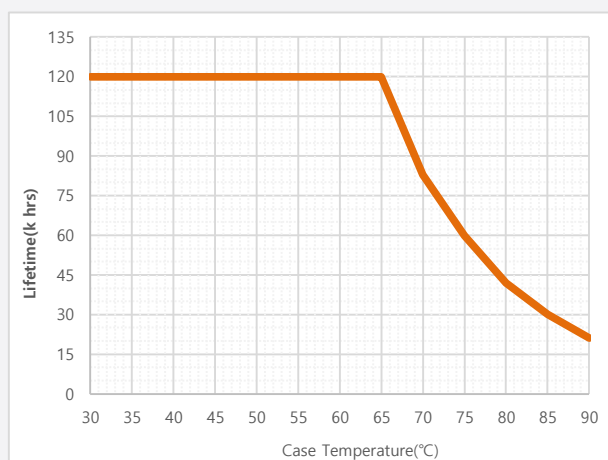

4. Output Current Setting Process

The programmable driver can be programmed by using special user interface software named Samsung Multi Programmer with configuration tool named SPC200. After installing the Samsung Multi Programmer, follow steps below.

- * Download link for software : http://cdn.samsung.com/led/file/data/Samsung_Multi_Programmer.zip and for detailed user manual : http://cdn.samsung.com/led/file/data/Manual_Samsung_multi_programmer_V1_200423.pdf

1. Connect PC, SPC200 and the programmable LED Driver as below.

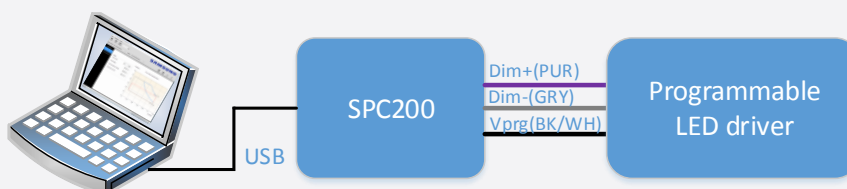

2. Run the Samsung Multi Programmer.exe.
3. Click the 'Start' button and then a new window will be appeared.

The screenshot shows the '0-10V Dimming Driver Configuration 1.0.0.0' software interface. The 'Output Current' tab is selected, and the 'Set Current' is set to 2.100 A. The 'Driver Output Operating Region' graph shows a red box indicating the 'Programmed operating area' with vertices at (0.42, 28), (2.1, 24.17), (2.1, 46.08), and (0.42, 46.08). The graph also shows the 'Max Voltage' at 46.0 V and 'Min Operational Voltage' at 24.2 V. The 'Driver Max Current' is 2.1 A. The 'Read' button is circled in red, and the 'Write' button is circled in blue.

4. Click 'Read' button to check set value. You can see a pop-up window with 'Successful Data Reading!' message.
5. Click 'Output Current' on the left menu and adjust the output current value. The programmed operating area will be changed according to set current.
6. Click 'Write' button to download the changed value into the LED driver. You can see a pop-up window with 'Programming was successful!' message.
7. Click 'Read' button again if you want to verify the programming result.

5. Dimming

5-1. 0-10V dimming

The recommended implementation of the dimming control is provided below.

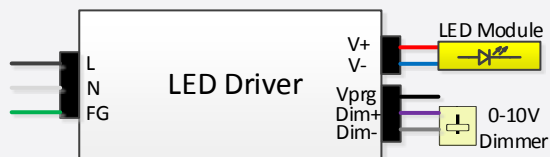

If 0-10V dimming is not used, Dim+ should be open.

The dimmer can also be replaced by an active 0-10V voltage source signal or passive components like resistor or zener.

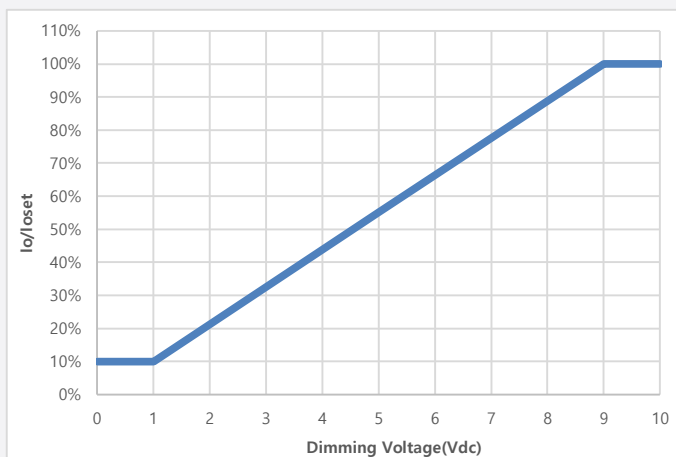

5-2. 10V PWM dimming

The recommended implementation of the dimming control is provided below.

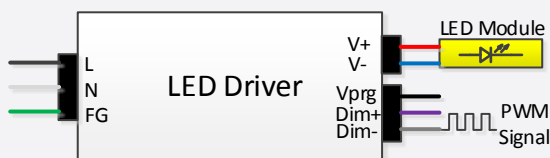

If PWM dimming is not used, Dim+ should be open.

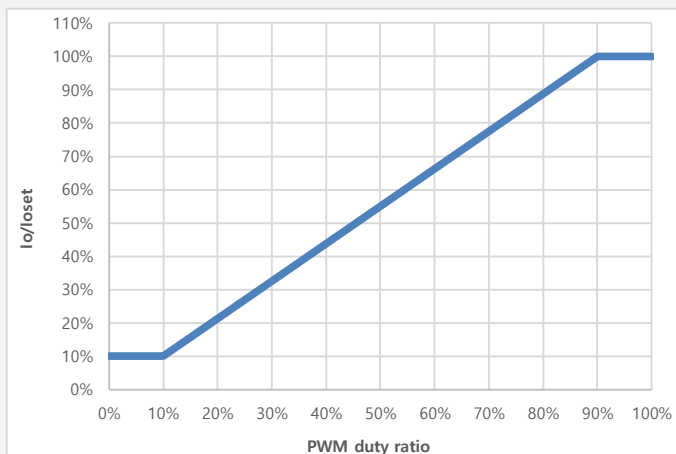

6. Reliability

Test Items and Conditions

Test Item	Specification	Condition
Leakage current	Vin=277Vac/60Hz < 0.75 MIU	UL8750
Hi-pot	Input – Output 3000 Vac, 60 s, ≤ 10 mA	Note 1.
	Input – Earth 2100 Vac, 60 s, ≤ 10 mA	
	Output – Earth 1500 Vac, 60 s, ≤ 10mA	
Insulation resistance	Input – Output 500 Vdc, 60 s, ≥ 10 MΩ	
	Input – Earth 500 Vdc, 60 s, ≥ 10 MΩ	
Surge	L / N ±6 kV	Combination waveform
	LN / FG ±10 kV	
ESD	Contact ±4 kV	
	Air ±8 kV	

Note.1 To perform electric strength(Hi-pot) and IR testing, the “GDT ground disconnect”(nut and metal lock sheet) on the driver end-cap should be removed temporarily to prevent the internal gas discharge tube from conducting (as allowed by IEC 60598-1 Clause 10.2).
After testing is completed, these items must be reinstalled to restore line-to-earth surge protection and secure the end cap.

7. Outline Drawing & Dimension

a) Dimension (mm)

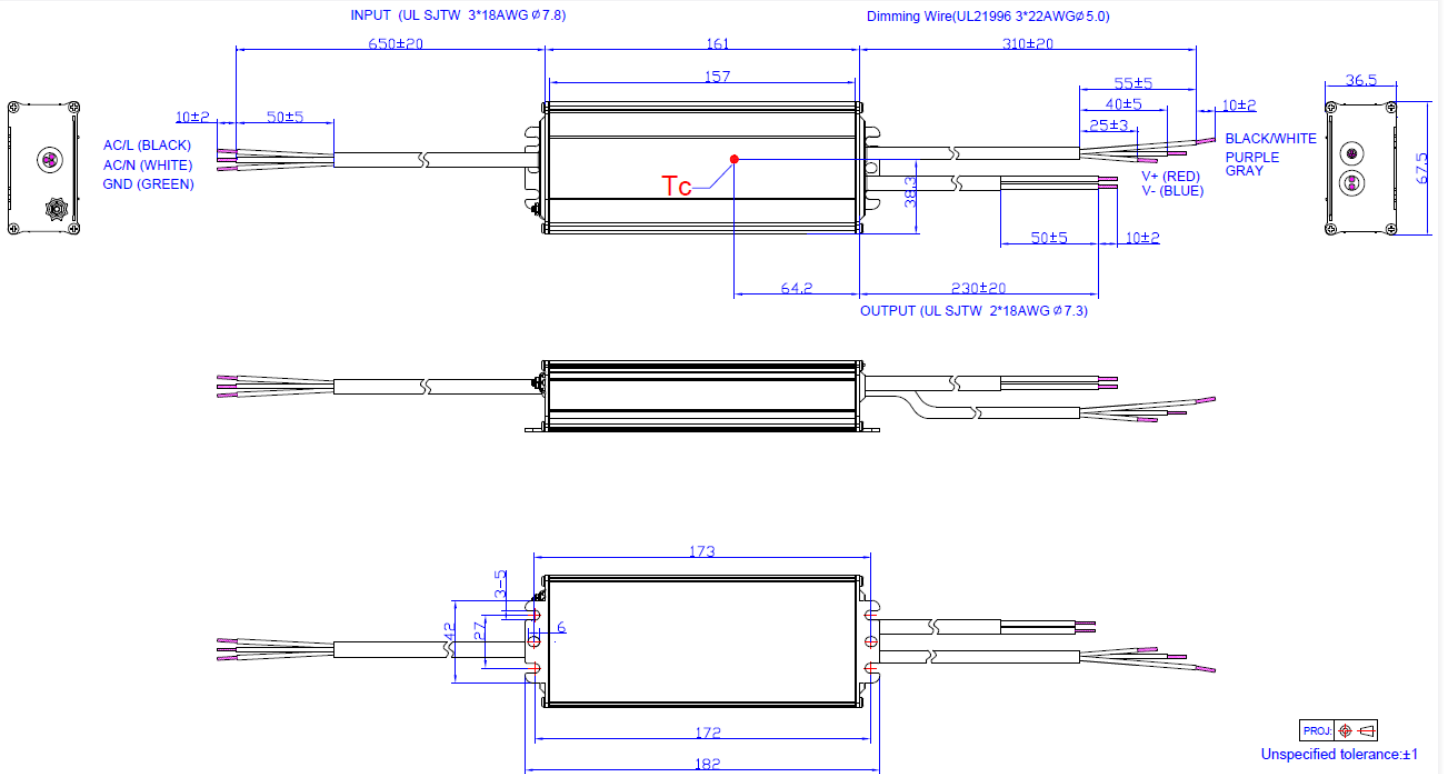

b) Wiring

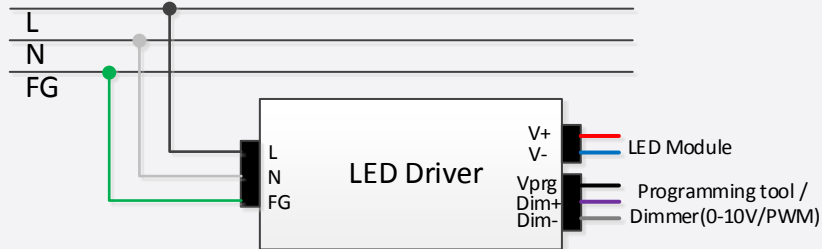

Name	Feature	Color	Purpose
V+	LED output	Red	Supply power to LED module
V-	Power ground	Blue	Power ground for V+
Vprg	Output current setting	BK/WH	Set output current through programming tool
DIM+	Dimming control	Purple	Connect a 0-10Vdc or PWM type dimmer
DIM-	Signal ground	Grey	Signal ground for DIM+ and Vprg

8. Label Structure

○ACL(BLK)	SAMSUNG Dimming:10%-100%	LED DRIVER Constant Current Type	MODEL:SL-LU2129601WW 0-10V/10V PWM Dimmable Type	Vprg (BK/WH)○ Dim+ (PUR)○ Dim-(GRY)○ V+ (RED)○
INPUT		INPUT 100-240/277*VAC, 50/60 Hz, 1.13A max OUTPUT 96W max, 24-69VDC, 2100mA max	•tc:88°C	○
○ACN (WHT)	*277VAC for North America Only For dry,damp and wet locations use Suitable For LED Module Use	U _{out} =89V	IP67	○
○⊕(GRN)			SELV TYPE HL MADE IN CHINA	○
				SL-LU2129601WW Configuration:N/A Initial Current:2100mA Firmware:2F0A0000

9. Packing Structure

Packing material	Max. quantity (pcs)	Dimension (mm)		
		Length	Width	Height
Outer box	20	490	300	305
Pallet	480 (24 outer boxes)	1100	1100	121

10. Precautions in Handling & Use

- To prevent the LED Driver from any defect, please handle and store it with care
 - Do not drop or give shock
 - Do not store in very humid location or at extreme temperature
 - Do not open or disassemble the product
- Static electricity or surge voltage may damage the components inside LED Driver, as such please observe proper anti-electrostatic working process
 - People handling the Driver should be well grounded (e.g. using ESD wrist band) and wear anti-static working clothes and gloves
 - All related devices and instruments in the production line should be well grounded (e.g. working table, measuring equipment, assembly jigs)
- Observe the correct polarity of output terminal
- Avoid input voltage exceeds the maximum rating, which will cause damage to the circuit and result in malfunction

11. Installation guide

The long-term reliability of the LED driver depends on the installation guide.

1) General instructions

- . The switching of LEDs on secondary side is not permitted.
- . Do not install the LED driver in places with high ambient temperature or near fire source.
 - Please refer to the specifications for the maximum ambient temperature limitations named max. ta.
 - During operation, the temperature measured at tc point must not exceed the specified max. tc.
- . Install the LED driver in a waterproof enclosure or at least under the cover to prevent direct exposure to rain or moving water.
 - Avoid cables bent or looped above the LED driver to prevent water from flowing to junction area.
 - Avoid a situations that the wire leads or end of cable jacket are exposed to moisture or wet environment.

2) Earth connection

- . The earth connection is conducted as protection earth(PE).
- . The LED driver can be earthed via metal housing. If the LED driver will be earthed, PE has to be used.
- . The earth connection is recommended to improve following behavior.
 - Electromagnetic interferences(EMI)
 - Lightning surge immunity from AC power line
 - Transmission of mains transients to the LED output
- . The PE between AC power line and the LED driver should be connected in common point as below.

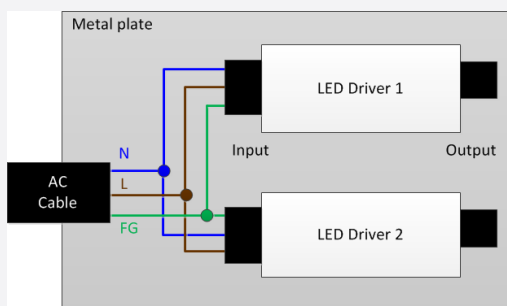

3) Wiring instruction

- . All connections should be kept as short as possible to ensure good EMI operation.
- . To reduce the EMI, don't cross the wire between input and output, don't put the wire above the LED driver as below.

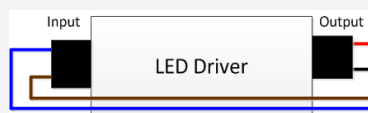
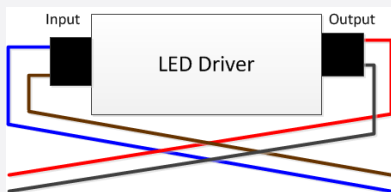

- . Main cables should be kept apart from the LED driver and other cables(more than 5~10cm distance).
- . It is recommended that the maximum length of the output wire be 5 meters or less.
- . Please ensure the correct polarity of the leads prior to commissioning. Reversed polarity can destroy the LED modules.
- . To avoid the damage of the LED driver, the wiring must be protected against short circuits to earth.

4) Fixing conditions

- . If the LED driver is destined for installation in a luminaire, sufficient heat transfer must be ensured between the LED driver and the luminaire casing.
- . The LED drivers should be mounted with enough clearance to heat sources.
- . Minimum distances stated on the right is recommended on the actual luminaire.
- . It is not suitable for fixing the LED driver at the corner.

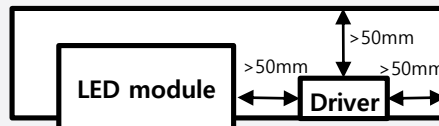

5) Example of EMI(RE) effect on wiring and earth connection

	Bad set-up	Good set-up
Photo of tunnel lighting fixture		
EMI(RE) measurement result		

Legal and additional information.

[About Samsung Electronics Co., Ltd.](#)

Samsung Electronics Co., Ltd inspires the world and shapes the future with transformative ideas and technologies.

The company is redefining the worlds of TVs, smartphones, wearable devices, tablets, digital appliances, network systems, and semiconductor and LED solutions. For the latest news, please visit the Samsung Newsroom at <http://news.samsung.com>.

Copyright © 2020 Samsung Electronics Co., Ltd. All rights reserved.
Samsung Electronics reserves the right to modify, at its sole discretion, the design, packaging, specifications and features shown herein without notice at any time.

Samsung Electronics Co., Ltd.
Samsung-ro, Giheung-gu
Yongin-si, Gyeonggi-do, 17113
KOREA
www.samsungled.com