

# AMPHENOL PART NUMBER CONFIGURATION

U95-R205-XXX1-TX1

REVISIONS			
REV	DESCRIPTION, ECN, EAR NO.	DATE	APP'D
A	NEW PROPOSAL	AUG 23/18	J.SI
B	MODIFY LED PAD DIMENSION	SEP 06/19	J.SI
C	CORRECT DRAWING ERROR	AUG 21/20	J.SI
D	ADD NEW OPTION	APR 21/21	J.SI

**CAGE & CONNECTOR CONTACT PLATING**  
 4 = 0.76 µm MIN. GOLD OVER 1.27-3.81 µm OF NICKEL ON MATING AREA  
 0.381-1.52 µm OF MATTE TIN OVER 1.27-3.81 µm OF NICKEL ON PRESS FIT TAIL AREA.  
 Ni PLATING FOR CAGE  
 (RoHS COMPLIANT PER RoHS DIRECTIVE 2011/65/EU)

**OPTIONAL DUST COVER**  
 0 = WITHOUT DUST COVER  
 D = WITH DUST COVER

**VENT HOLES AND EMI COVER**  
 0 = WITH LARGE VENT HOLES & WITH EMI COVER  
 2 = WITH SMALL VENT HOLES & WITH EMI COVER  
 4 = WITH RECTANGULAR VENT HOLES & WITH EMI COVER

**EMI GASKET**  
 T = THROUGH THE BEZEL; WITH LONG SPRING FINGER, WITH 3 LATCHES ON SPRING FINGERS

**OPTIONAL LIGHT PIPES**  
 6 = WITH LIGHT PIPE (TRIANGULAR OUTLET)  
 LEFT ARROW POINTING BOTTOM PORT & RIGHT ARROW POINTING TOP PORT  
 7 = WITHOUT LIGHT PIPE  
 8 = WITH LIGHT PIPE (REVERSED DIRECTION)  
 LEFT ARROW POINTING TOP PORT & RIGHT ARROW POINTING BOTTOM PORT  
 C = WITHOUT LIGHT PIPE, WITH 28 RECTANGULAR VENT HOLES

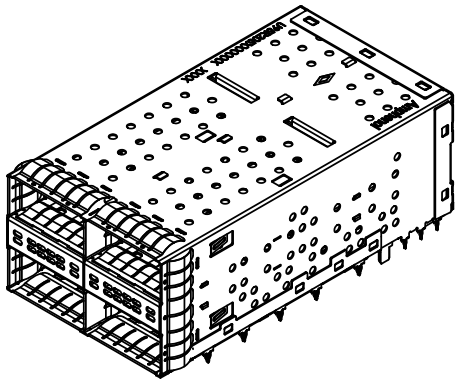

U95-R205-4X71-T41

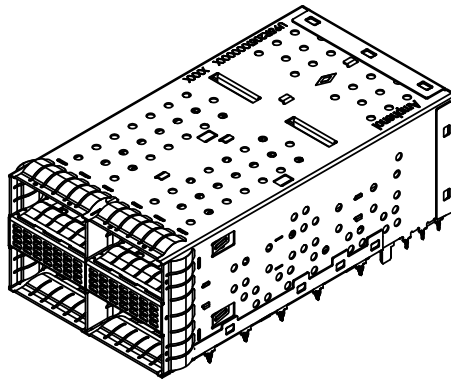

U95-R205-4XC1-T41



VENT HOLE FOR PART NUMBER U95-R205-XX71-T01

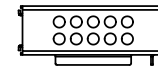

VENT HOLE FOR PART NUMBER U95-R205-XX71-T21

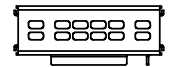

VENT HOLE FOR PART NUMBER U95-R205-XX71-T41



VENT HOLE FOR PART NUMBER U95-R205-XX61-T01

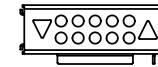

VENT HOLE FOR PART NUMBER U95-R205-XX61-T21

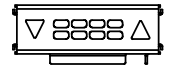

VENT HOLE FOR PART NUMBER U95-R205-XX61-T41



VENT HOLE FOR PART NUMBER U95-R205-XX81-T01

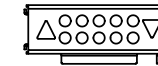

VENT HOLE FOR PART NUMBER U95-R205-XX81-T21

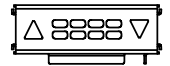

VENT HOLE FOR PART NUMBER U95-R205-XX81-T41

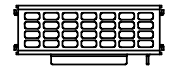

VENT HOLE FOR PART NUMBER U95-R205-XXC1-T41

**NOTES:**

- MATERIAL  
 CAGE-PRESS FIT: COPPER ALLOY, NICKEL PLATED  
 CONNECTOR-PRESS FIT: PLASTIC HOUSING, FLAMMABILITY RATING UL94 V-0.  
 CONTACTS: PHOSPHOR BRONZE  
 PLATING OPTION: SEE AMPHENOL PART ON CONFIGURATION  
 LIGHT PIPE: GE LEXAN, OPTICAL GRADE  
 DUST COVER (IF ORDERED) SHIPPED LOOSE

UNLESS SPECIFIED OTHERWISE	DRAWN	Shawn.Li	AUG 23/18
PRIMARY UNITS	MILLIMETERS	CHECKED	Eric.Z
SECONDARY	MILLIMETERS	M.E. APP'D	AUG 23/18
REFERENCE IN PARENTHESES	Q.A. APP'D		
GENERAL TOLERANCES	DWG APP'D	J.SI	AUG 23/18
1 DECIMAL PLACE	±0.25	ENG. REL. NO.	
2 DECIMAL PLACES	±0.15	REF.	
ANGULAR DEGREES	±0.5°	THIRD ANGLE PROJECTION	

**Amphenol High Speed Interconnects**  
 A Division of Amphenol Corp. [www.amphenol-highspeed.com](http://www.amphenol-highspeed.com)

**ExtremePort QSFP+ 2X2 STACKED COMBO WITH EMI SPRING FINGER 4X56G**

DWG. NO. **P-U95-R205-XXX1-TX1** REV **D**

CODE ID NO. **03554** DWG SIZE: **C** SCALE: **1:1** SHEET **1** OF **4**

REVISIONS			
REV	DESCRIPTION, ECN, EAR NO.	DATE	APP'D
A	NEW PROPOSAL	AUG 23/18	J.SI
B	MODIFY LED PAD DIMENSION	SEP 06/19	J.SI
C	CORRECT DRAWING ERROR	AUG 21/20	J.SI
D	ADD NEW OPTION	APR 21/21	J.SI

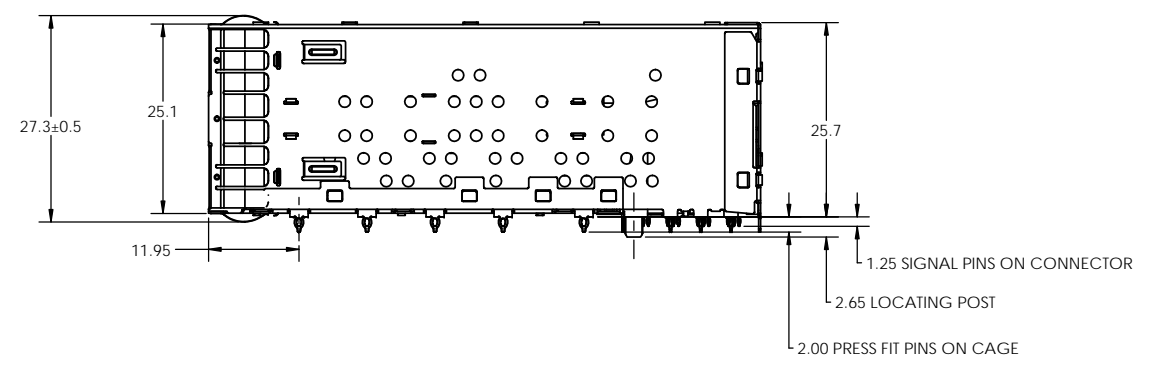
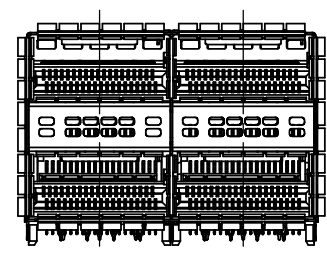
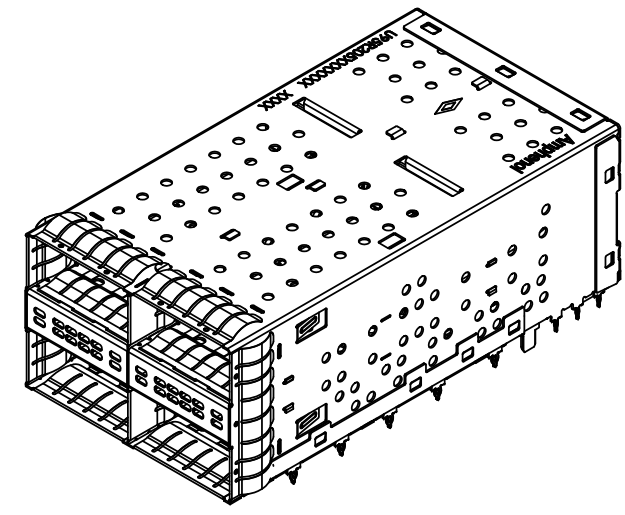
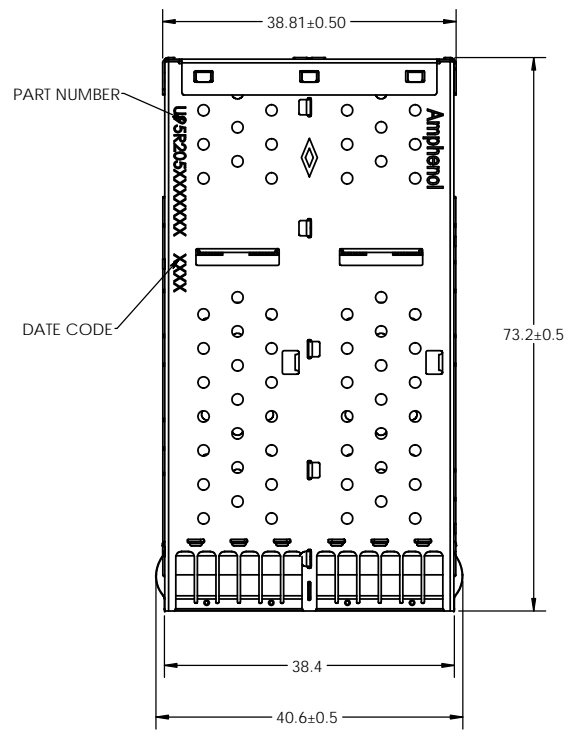

UNLESS SPECIFIED OTHERWISE		DRAWN	Shawn.Li	AUG 23/18
PRIMARY UNITS	MILLIMETERS	CHECKED	Eric.Z	AUG 23/18
SECONDARY	MILLIMETERS	M.E.	APP'D	
REFERENCE IN PARENTHESES		Q.A.	APP'D	
GENERAL TOLERANCES		DWG.	APP'D	J.SI
1 DECIMAL PLACE		AUG 23/18		
2 DECIMAL PLACES		ENG. REL. NO.		
ANGULAR DEGREES		REF.		
±0.25		THIRD ANGLE PROJECTION		
±0.15		DO NOT SCALE DRAWING		
±0.5°				

**Amphenol High Speed Interconnects**  
 A Division of Amphenol Corp. [www.amphenol-highspeed.com](http://www.amphenol-highspeed.com)

**ExtremePort QSFP+ 2X2  
 STACKED COMBO  
 WITH EMI SPRING FINGER  
 4X56G**

DWG. NO. **P-U95-R205-XXX1-TX1** REV **D**

CODE ID NO. **03554** DWG SIZE: **C** SCALE: **1:1** SHEET **2** OF **4**

THIS DOCUMENT CONTAINS PROPRIETARY INFORMATION AND SUCH INFORMATION MAY NOT BE DISCLOSED TO OTHERS FOR ANY PURPOSE OR USED FOR MANUFACTURING PURPOSES WITHOUT WRITTEN PERMISSION FROM AMPHENOL CANADA CORP.

REVISIONS			
REV	DESCRIPTION, ECN, EAR NO.	DATE	APP'D
A	NEW PROPOSAL	AUG 23/18	J.SI
B	MODIFY LED PAD DIMENSION	SEP 06/19	J.SI
C	CORRECT DRAWING ERROR	AUG 21/20	J.SI
D	ADD NEW OPTION	APR 21/21	J.SI

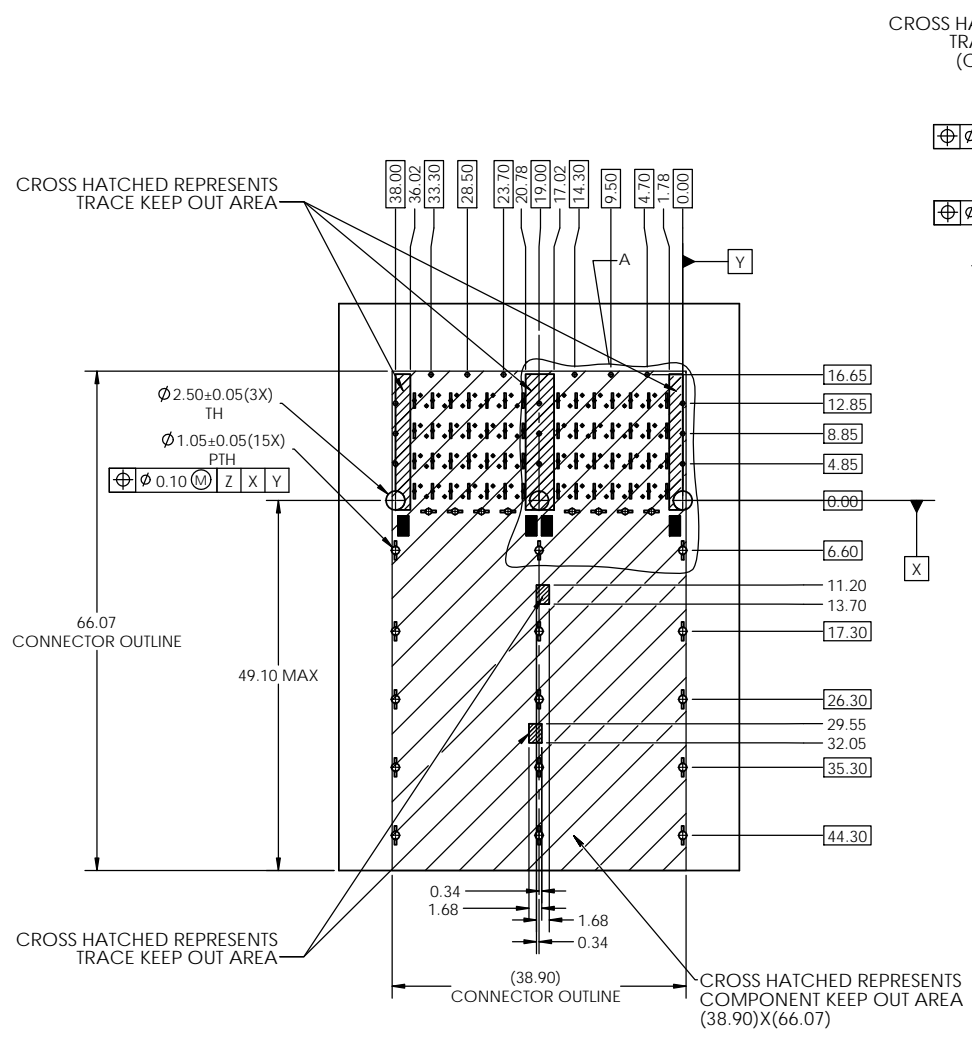

CROSS HATCHED REPRESENTS TRACE KEEP OUT AREA (CAGE PRESS FIT PINS)

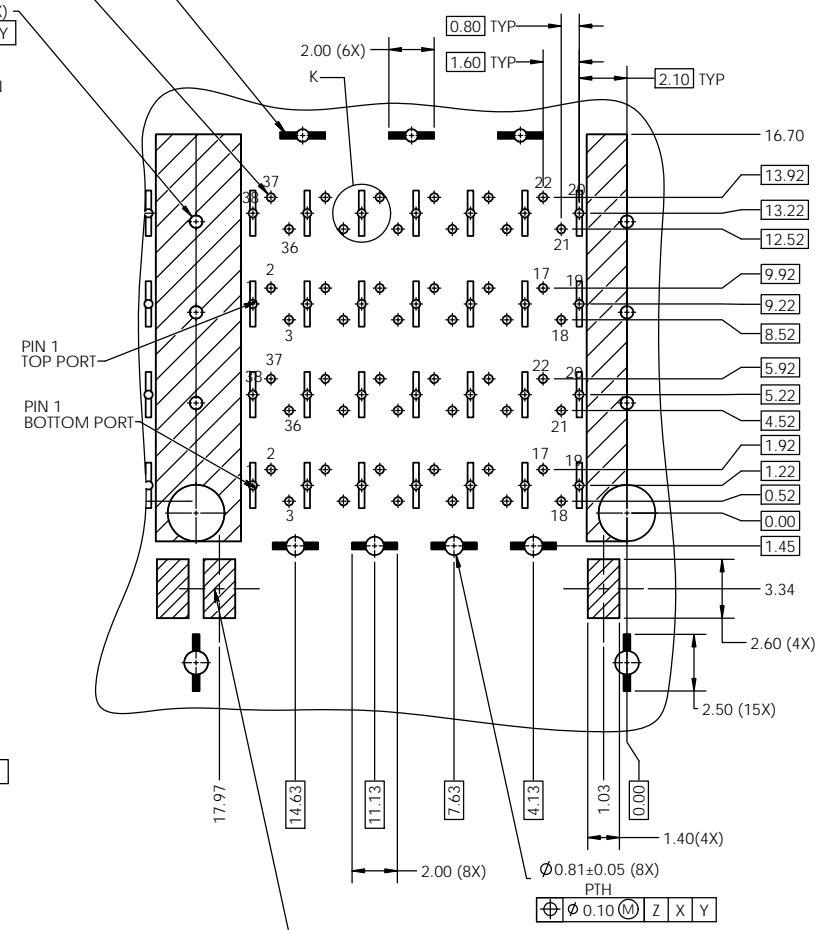
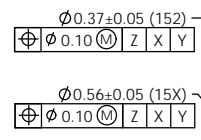

RECOMMENDED PCB BOARD LAYOUT COMPONENT SIDE SHOWN

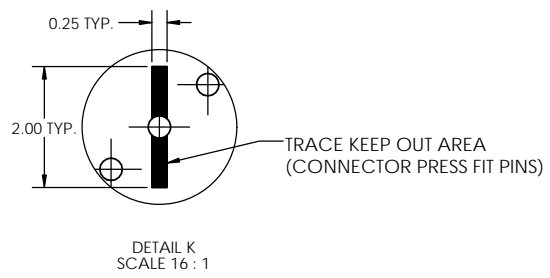

CROSS HATCHED REPRESENTS LED SOLDER PAD SEATING AREA EXTENDING VERTICALLY 0.80 mm ABOVE THE TOP OF HOST PCB

DETAIL A SCALE 6:1

UNLESS SPECIFIED OTHERWISE		DRAWN	Shawn.Li	AUG 23/18
PRIMARY UNITS	MILLIMETERS	CHECKED	Eric.Z	AUG 23/18
SECONDARY	MILLIMETERS	M.E. APP'D		
REFERENCE IN PARENTHESES		Q.A. APP'D		
GENERAL TOLERANCES		DWG APP'D	J.SI	AUG 23/18
1 DECIMAL PLACE	±0.25	ENG. REL. NO.		
2 DECIMAL PLACES	±0.05	REF.		
ANGULAR DEGREES	±0.5°	THIRD ANGLE PROJECTION		DO NOT SCALE DRAWING

**Amphenol High Speed Interconnects**  
 A Division of Amphenol Corp. [www.amphenol-highspeed.com](http://www.amphenol-highspeed.com)

**ExtremePort QSFP+ 2X2 STACKED COMBO WITH EMI SPRING FINGER 4X56G**

DWG. NO. **P-U95-R205-XXX1-TX1** REV **D**

CODE ID. NO. **03554** DWG. SIZE: **C** SCALE: **2:1** SHEET **3** OF **4**

REVISIONS			
REV	DESCRIPTION, E.C.N., E.A.R. NO.	DATE	APP'D
A	NEW PROPOSAL	AUG 23/18	J.SI
B	MODIFY LED PAD DIMENSION	SEP 06/19	J.SI
C	CORRECT DRAWING ERROR	AUG 21/20	J.SI
D	ADD NEW OPTION	APR 21/21	J.SI

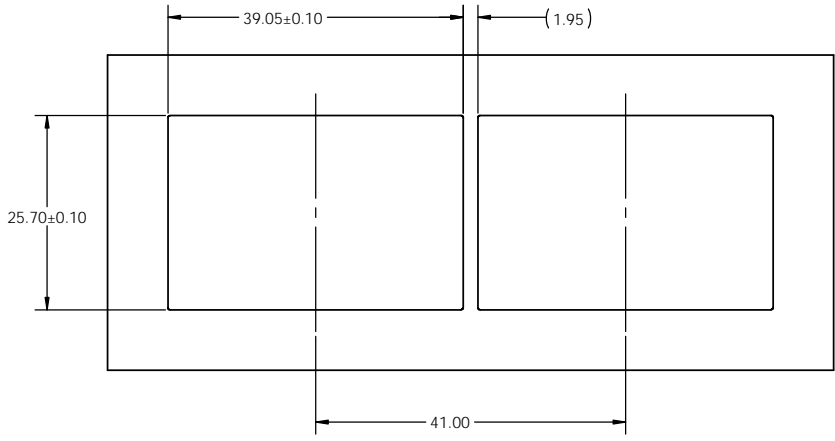
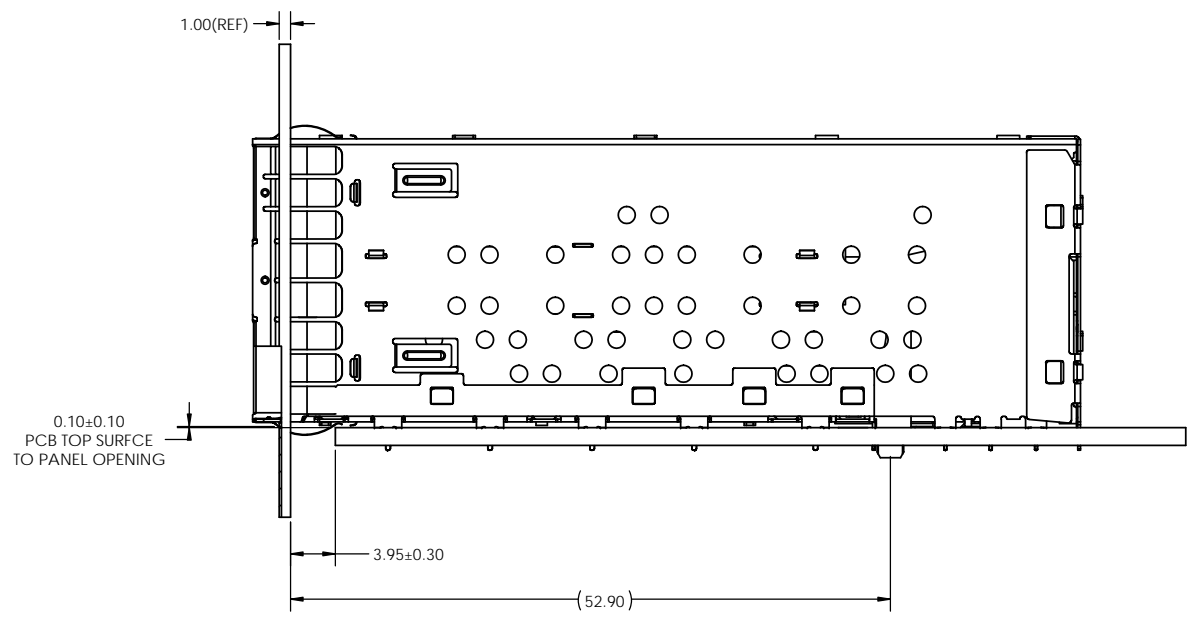

UNLESS SPECIFIED OTHERWISE		DRAWN	Shawn.Li	AUG 23/18
PRIMARY UNITS	MILLIMETERS	CHECKED	Eric.Z	AUG 23/18
SECONDARY	MILLIMETERS	M.E. APP'D		
REFERENCE IN PARENTHESES		Q.A. APP'D		
GENERAL TOLERANCES		DWG. APP'D	J.SI	AUG 23/18
1 DECIMAL PLACE	±0.25	ENG. REL. NO.		
2 DECIMAL PLACES	±0.10	REF.		
ANGULAR DEGREES	±0.5°	THIRD ANGLE PROJECTION		DO NOT SCALE DRAWING

**Amphenol High Speed Interconnects**  
 A Division of Amphenol Corp. [www.amphenol-highspeed.com](http://www.amphenol-highspeed.com)

**ExtremePort QSFP+ 2X2  
 STACKED COMBO  
 WITH EMI SPRING FINGER  
 4X56G**

DWG. NO. **P-U95-R205-XXX1-TX1** REV **D**

CODE ID. NO. **03554** DWG. SIZE: **C** SCALE: **1:1** SHEET **4** OF **4**

THIS DOCUMENT CONTAINS PROPRIETARY INFORMATION AND SUCH INFORMATION MAY NOT BE DISCLOSED TO OTHERS FOR ANY PURPOSE OR USED FOR MANUFACTURING PURPOSES WITHOUT WRITTEN PERMISSION FROM AMPHENOL CANADA CORP.