

**MSCSM70TAM05TPAG**  
**Datasheet**  
**Triple Phase Leg SiC MOSFET Power Module**

April 2020



---

a  **MICROCHIP** company

# Contents

---

<b>1 Revision History.....</b>	<b>1</b>
1.1 Revision 1.0.....	1
<b>2 Product Overview.....</b>	<b>2</b>
2.1 Features.....	3
2.2 Benefits.....	3
2.3 Applications.....	3
<b>3 Electrical Specifications.....</b>	<b>4</b>
3.1 SiC MOSFET Characteristics (Per MOSFET).....	4
3.2 Thermal and Package Characteristics.....	6
3.3 Typical SiC MOSFET Performance Curves.....	7
<b>4 Package Specifications.....</b>	<b>10</b>
4.1 Package Outline Drawing.....	10

# 1 Revision History

---

The revision history describes the changes that were implemented in the document. The changes are listed by revision, starting with the most current publication.

## 1.1 Revision 1.0

Revision 1.0 was published in April 2020. It is the first publication of this document.

## 2 Product Overview

The MSCSM70TAM05TPAG device is a triple phase leg 700 V/349 A full silicon carbide (SiC) power module.

**Figure 1 • MSCSM70TAM05TPAG Electric Schematic**

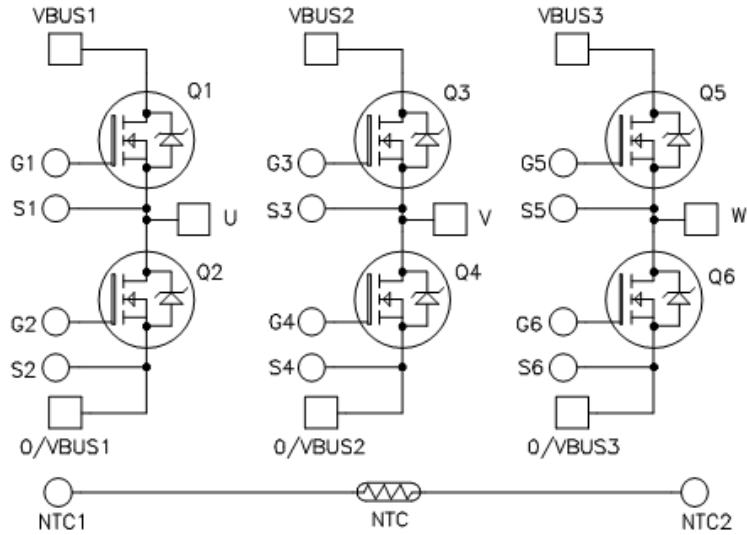

**Figure 2 • MSCSM70TAM05TPAG Pinout Location**

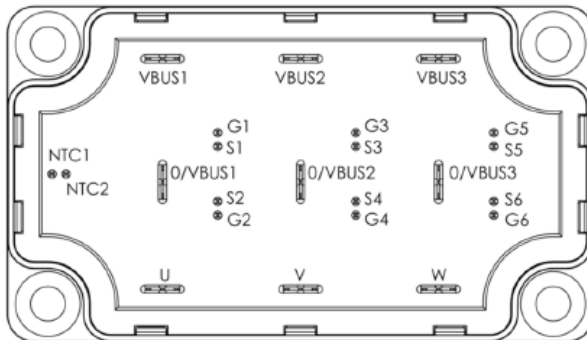

All ratings at  $T_j = 25\text{ }^\circ\text{C}$ , unless otherwise specified.

**Caution:** These devices are sensitive to electrostatic discharge. Proper handling procedures should be followed.

## 2.1 Features

The following are key features of the MSCSM70TAM05TPAG device:

- SiC Power MOSFET
  - Low  $R_{DS(on)}$
  - High-speed switching
  - Ultra low loss
- Very low stray inductance
- Kelvin source for easy drive
- Internal thermistor for temperature monitoring
- Aluminum nitride (AlN) substrate for improved thermal performance

## 2.2 Benefits

The following are benefits of the MSCSM70TAM05TPAG device:

- High-efficiency converter
- Outstanding performance at high-frequency operation
- Direct mounting to heatsink (isolated package)
- Low junction-to-case thermal resistance
- Solderable terminals for power and signal, for easy PCB mounting
- Low profile
- RoHS compliant

## 2.3 Applications

The MSCSM70TAM05TPAG device is designed for the following applications:

- Uninterruptible power supplies
- Switched mode power supplies
- EV motor and traction drive
- Welding converters

## 3 Electrical Specifications

This section shows the electrical specifications of the MSCSM70TAM05TPAG device.

### 3.1 SiC MOSFET Characteristics (Per MOSFET)

The following table shows the absolute maximum ratings per SiC MOSFET of the MSCSM70TAM05TPAG device.

**Table 1 • Absolute Maximum Ratings**

Symbol	Parameter	Max Ratings	Unit
$V_{DSS}$	Drain-source voltage	700	V
$I_D$	Continuous drain current	$T_C = 25\text{ }^\circ\text{C}$	349 <sup>1</sup>
		$T_C = 80\text{ }^\circ\text{C}$	278 <sup>1</sup>
$I_{DM}$	Pulsed drain current	700	
$V_{GS}$	Gate-source voltage	-10/25	V
$R_{DS(on)}$	Drain-source ON resistance	6.4	m $\Omega$
$P_D$	Power dissipation	$T_C = 25\text{ }^\circ\text{C}$	966

**Note:**

1. Specification of the SiC MOSFET device, but output current must be limited due to size of power connectors.

The following table shows the electrical characteristics per SiC MOSFET of the MSCSM70TAM05TPAG device.

**Table 2 • Electrical Characteristics**

Symbol	Characteristic	Test Conditions	Min	Typ	Max	Unit
$I_{DSS}$	Zero gate voltage drain current	$V_{GS} = 0\text{ V}; V_{DS} = 700\text{ V}$			300	$\mu\text{A}$
$R_{DS(on)}$	Drain-source on resistance	$V_{GS} = 20\text{ V}$ $I_D = 120\text{ A}$	$T_J = 25\text{ }^\circ\text{C}$	5	6.4	m $\Omega$
			$T_J = 175\text{ }^\circ\text{C}$		6.3	
$V_{GS(th)}$	Gate threshold voltage	$V_{GS} = V_{DS}, I_D = 12\text{ mA}$	1.9	2.4		V
$I_{GSS}$	Gate-source leakage current	$V_{GS} = 20\text{ V}, V_{DS} = 0\text{ V}$			300	nA

The following table shows the dynamic characteristics per SiC MOSFET of the MSCSM70TAM05TPAG device.

**Table 3 • Dynamic Characteristics**

Symbol	Characteristic	Test Conditions	Min	Typ	Max	Unit
$C_{iss}$	Input capacitance	$V_{GS} = 0\text{ V}$ $V_{DS} = 700\text{ V}$ $f = 1\text{ MHz}$		13.5		nF
$C_{oss}$	Output capacitance			1.5		
$C_{rss}$	Reverse transfer capacitance			0.09		
$Q_g$	Total gate charge	$V_{GS} = -5\text{ V}/20\text{ V}$ $V_{Bus} = 470\text{ V}$ $I_D = 120\text{ A}$		645		nC
$Q_{gs}$	Gate-source charge			174		
$Q_{gd}$	Gate-drain charge			105		
$T_{d(on)}$	Turn-on delay time	$V_{GS} = -5\text{ V}/20\text{ V}$ $V_{Bus} = 400\text{ V}$ $I_D = 240\text{ A}; T_J = 150\text{ }^\circ\text{C}$ $R_{Gon} = 9\text{ }\Omega; R_{Goff} = 1.6\text{ }\Omega$		40		ns
$T_r$	Rise time			35		
$T_{d(off)}$	Turn-off delay time			50		
$T_f$	Fall time			20		
$E_{on}$	Turn on energy	Inductive switching	$T_J = 150\text{ }^\circ\text{C}$	1.96		mJ
$E_{off}$	Turn off energy	$V_{GS} = -5\text{ V}/20\text{ V}$ $V_{Bus} = 400\text{ V}$ $I_D = 160\text{ A}$ $R_{Gon} = 9\text{ }\Omega$ $R_{Goff} = 1.6\text{ }\Omega$	$T_J = 150\text{ }^\circ\text{C}$	0.56		mJ
$R_{Gint}$	Internal gate resistance			1.9		$\Omega$
$R_{thJC}$	Junction-to-case thermal resistance				0.155	$^\circ\text{C}/\text{W}$

The following table shows the body diode ratings and characteristics per SiC MOSFET of the MSCSM70TAM05TPAG device.

**Table 4 • Body Diode Ratings and Characteristics**

Symbol	Characteristic	Test Conditions	Min	Typ	Max	Unit
$V_{SD}$	Diode forward voltage	$V_{GS} = 0\text{ V}; I_{SD} = 120\text{ A}$		3.4		V
		$V_{GS} = -5\text{ V}; I_{SD} = 120\text{ A}$		3.8		
$t_{rr}$	Reverse recovery time	$I_{SD} = 120\text{ A}; V_{GS} = -5\text{ V}$ $V_R = 400\text{ V}; d_i/dt = 3000\text{ A}/\mu\text{s}$		38		ns
$Q_{rr}$	Reverse recovery charge			954		nC
$I_{rr}$	Reverse recovery current				44	

### 3.2 Thermal and Package Characteristics

The following table shows the package characteristics of the MSCSM70TAM05TPAG device.

**Table 5 • Thermal and Package Characteristics**

Symbol	Characteristic	Min	Max	Unit		
V <sub>ISOL</sub>	RMS isolation voltage, any terminal to case t = 1 min, 50 Hz/60 Hz	4000		V		
T <sub>J</sub>	Operating junction temperature range	-40	175	°C		
T <sub>JOP</sub>	Recommended junction temperature under switching conditions	-40	T <sub>Jmax</sub> -25			
T <sub>STG</sub>	Storage temperature range	-40	125			
T <sub>C</sub>	Operating case temperature	-40	125			
Torque	Mounting torque	To heatsink	M6	3	5	N.m
Wt	Package weight				250	g

The following table shows the temperature sensor NTC (see application note [APT0406](#) on [www.microsemi.com](http://www.microsemi.com)) of the MSCSM70TAM05TPAG device.

**Table 6 • Temperature Sensor NTC**

Symbol	Characteristic	Min	Typ	Max	Unit
R <sub>25</sub>	Resistance at 25 °C		50		kΩ
ΔR <sub>25</sub> /R <sub>25</sub>			5		%
B <sub>25/85</sub>	T <sub>25</sub> = 298.15 K		3952		K
ΔB/B	T <sub>C</sub> = 100 °C		4		%

$$R_T = \frac{R_{25}}{\exp\left[B_{25/85}\left(\frac{1}{T_{25}} - \frac{1}{T}\right)\right]}$$

T: Thermistor temperature  
R<sub>T</sub>: Thermistor value at T



### 3.3 Typical SiC MOSFET Performance Curves

This sections shows the typical SiC MOSFET performance curves of the MSCSM70TAM05TPAG device.

**Figure 3 • Maximum Thermal Impedance**

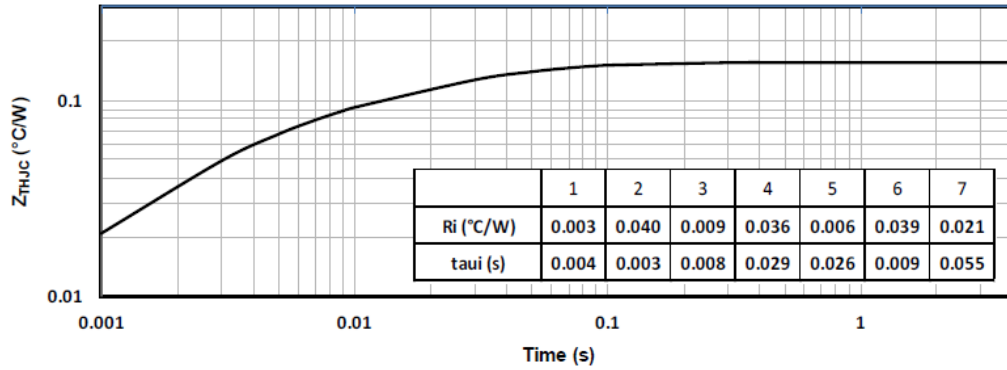

**Figure 4 • Output Characteristics,  $T_J = 25^\circ\text{C}$**

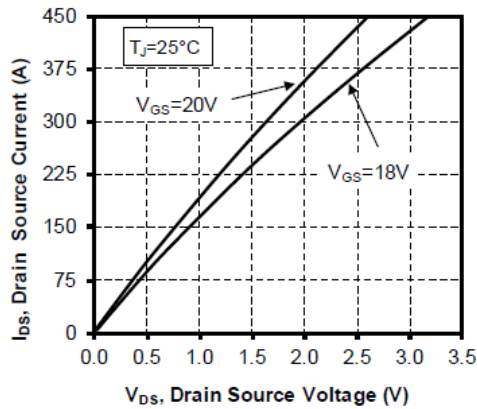

**Figure 5 • Output Characteristics,  $T_J = 175^\circ\text{C}$**

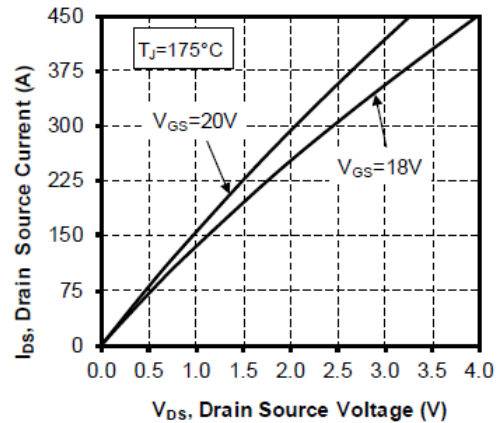

**Figure 6 • Normalized  $R_{DS(on)}$  vs. Temperature**

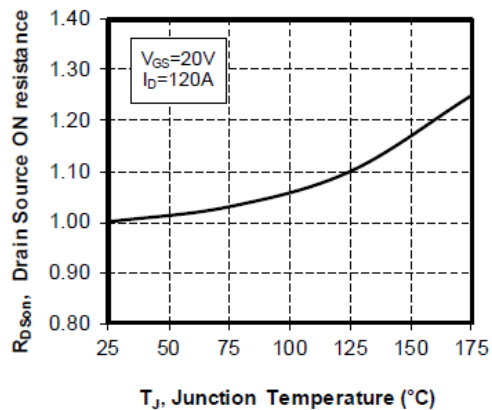

**Figure 7 • Transfer Characteristics**

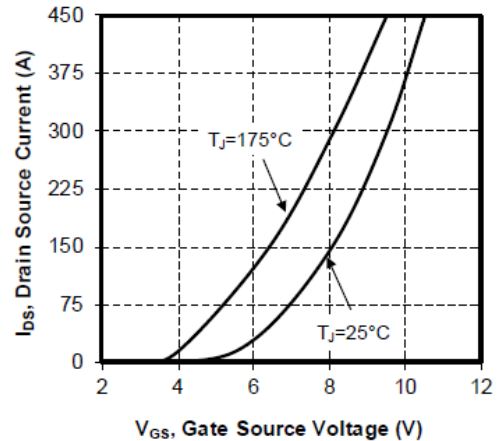

**Figure 8 • Capacitance vs. Drain Source Voltage**

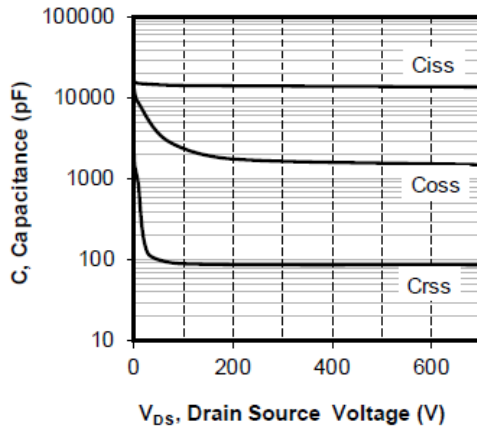

**Figure 9 • Gate Charge vs. Gate Source Voltage**

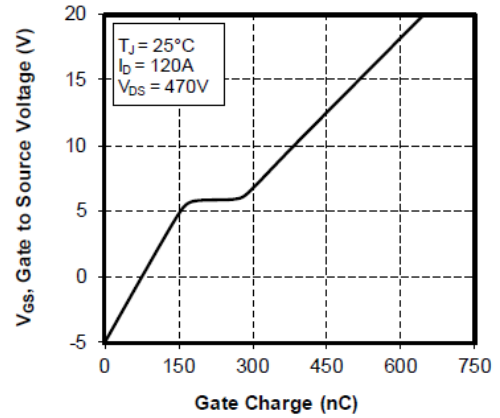

**Figure 10 • Body Diode Characteristics,  $T_J = 25^\circ\text{C}$**

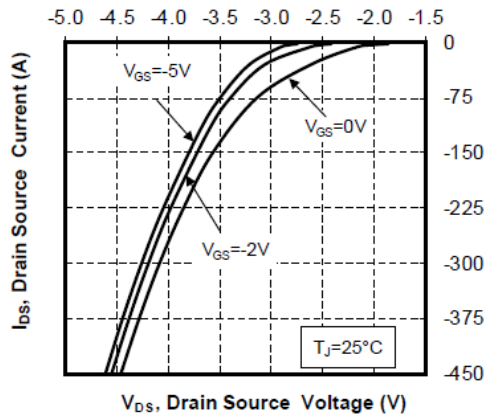

**Figure 11 • 3<sup>rd</sup> Quadrant Characteristics,  $T_J = 25^\circ\text{C}$**

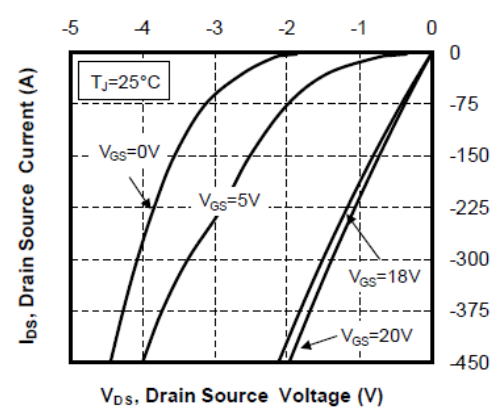

**Figure 12 • Body Diode Characteristics,  $T_J = 175^\circ\text{C}$**

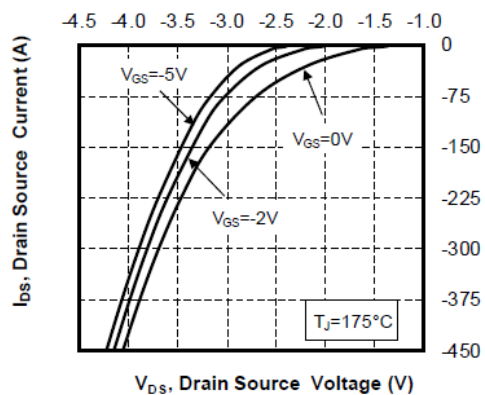

**Figure 13 • 3<sup>rd</sup> Quadrant Characteristics,  $T_J = 175^\circ\text{C}$**

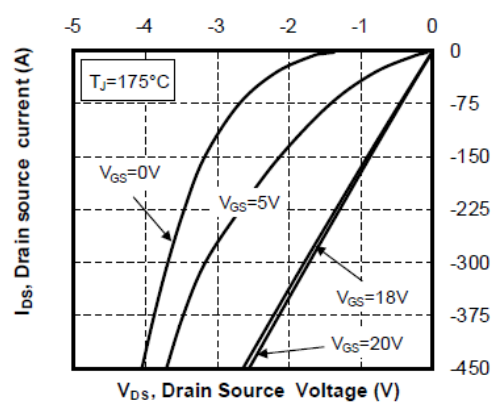

**Figure 14 • Switching Energy vs. Current**

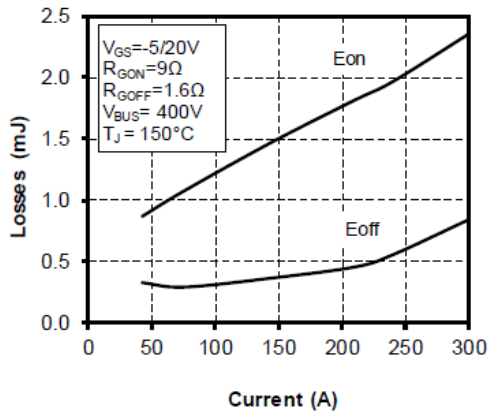

**Figure 15 • Turn On Energy vs. Rg**

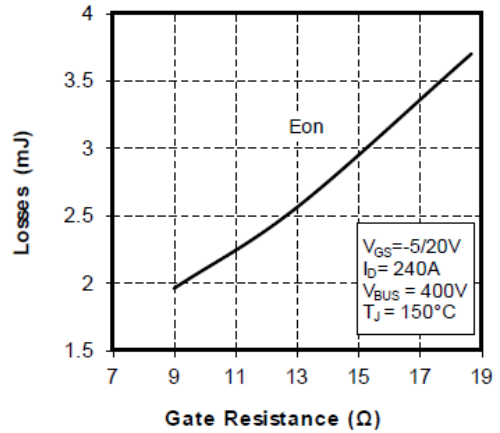

**Figure 16 • Turn Off Energy vs. Rg**

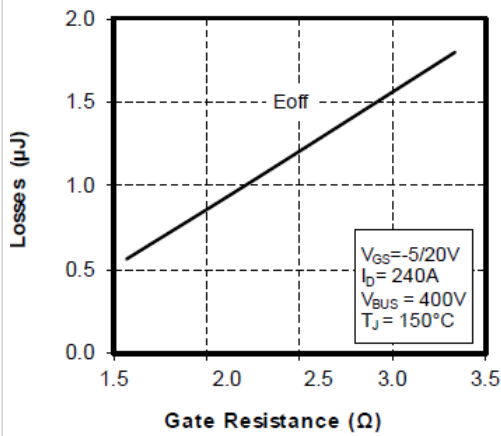

**Figure 17 • Operating Frequency vs Drain Current**

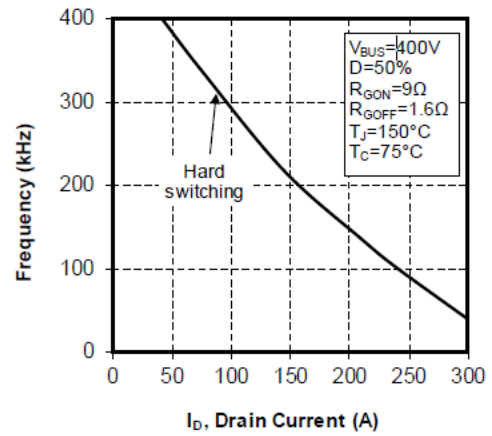

## 4 Package Specifications

This section shows the package specification of the MSCSM70TAM05TPAG device.

### 4.1 Package Outline Drawing

This section shows the package outline drawing of the MSCSM70TAM05TPAG device. The dimensions in the following figure are in millimeters.

Figure 18 • Package Outline Drawing

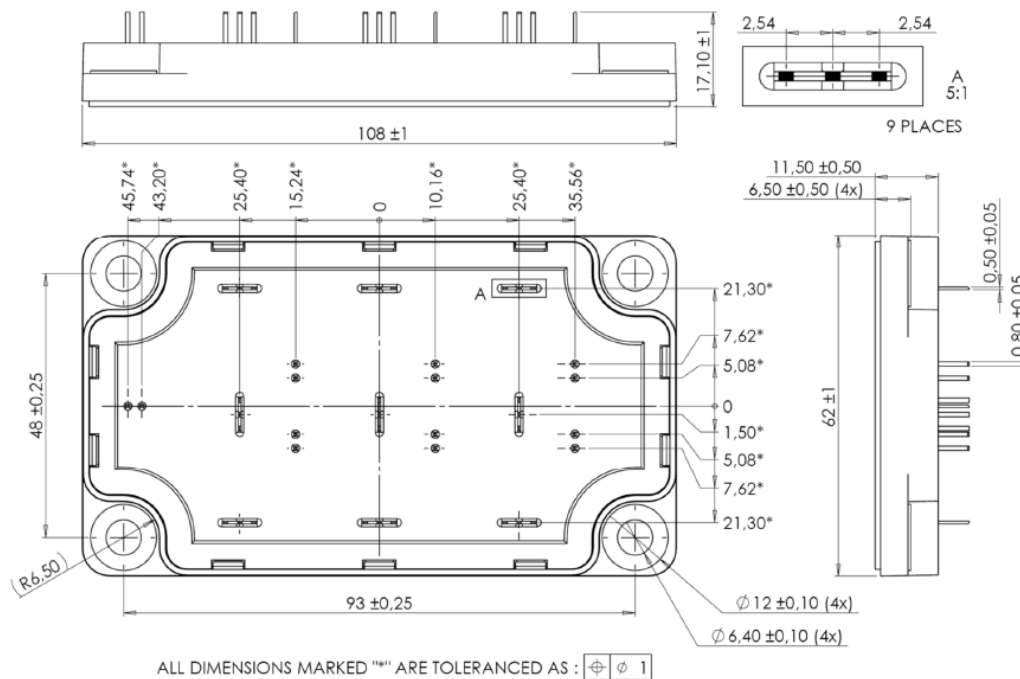

**Note:** See application note [1902 - Mounting Instructions for SP6-P \(12 mm\) Power Modules](#) on [www.microsemi.com](http://www.microsemi.com).

**Microsemi**

2355 W. Chandler Blvd.  
 Chandler, AZ 85224 USA

Within the USA: +1 (480) 792-7200  
 Fax: +1 (480) 792-7277

www.microsemi.com © 2020 Microsemi and its corporate affiliates. All rights reserved. Microsemi and the Microsemi logo are trademarks of Microsemi Corporation and its corporate affiliates. All other trademarks and service marks are the property of their respective owners.

Microsemi's product warranty is set forth in Microsemi's Sales Order Terms and Conditions. Information contained in this publication is provided for the sole purpose of designing with and using Microsemi products. Information regarding device applications and the like is provided only for your convenience and may be superseded by updates. Buyer shall not rely on any data and performance specifications or parameters provided by Microsemi. It is your responsibility to ensure that your application meets with your specifications. THIS INFORMATION IS PROVIDED "AS IS." MICROSEMI MAKES NO REPRESENTATIONS OR WARRANTIES OF ANY KIND WHETHER EXPRESS OR IMPLIED, WRITTEN OR ORAL, STATUTORY OR OTHERWISE, RELATED TO THE INFORMATION, INCLUDING BUT NOT LIMITED TO ITS CONDITION, QUALITY, PERFORMANCE, NON-INFRINGEMENT, MERCHANTABILITY OR FITNESS FOR A PARTICULAR PURPOSE. IN NO EVENT WILL MICROSEMI BE LIABLE FOR ANY INDIRECT, SPECIAL, PUNITIVE, INCIDENTAL OR CONSEQUENTIAL LOSS, DAMAGE, COST OR EXPENSE WHATSOEVER RELATED TO THIS INFORMATION OR ITS USE, HOWEVER CAUSED, EVEN IF MICROSEMI HAS BEEN ADVISED OF THE POSSIBILITY OR THE DAMAGES ARE FORESEEABLE. TO THE FULLEST EXTENT ALLOWED BY LAW, MICROSEMI'S TOTAL LIABILITY ON ALL CLAIMS IN RELATED TO THIS INFORMATION OR ITS USE WILL NOT EXCEED THE AMOUNT OF FEES, IF ANY, YOU PAID DIRECTLY TO MICROSEMI FOR THIS INFORMATION. Use of Microsemi devices in life support, mission-critical equipment or applications, and/or safety applications is entirely at the buyer's risk, and the buyer agrees to defend and indemnify Microsemi from any and all damages, claims, suits, or expenses resulting from such use. No licenses are conveyed, implicitly or otherwise, under any Microsemi intellectual property rights unless otherwise stated.

Microsemi Corporation, a subsidiary of Microchip Technology Inc. (Nasdaq: MCHP), and its corporate affiliates are leading providers of smart, connected and secure embedded control solutions. Their easy-to-use development tools and comprehensive product portfolio enable customers to create optimal designs which reduce risk while lowering total system cost and time to market. These solutions serve more than 120,000 customers across the industrial, automotive, consumer, aerospace and defense, communications and computing markets. Headquartered in Chandler, Arizona, the company offers outstanding technical support along with dependable delivery and quality. Learn more at [www.microsemi.com](http://www.microsemi.com).

MSCC-0344-DS-01083