

# Approval Sheet

## (產品承認書)

產品名稱 (Product)	<u>Bluetooth Low Energy Module</u>
解決方案 (Solution)	<u>Nordic nRF52805 WLCSP Package</u>
產品型號 (Model No.)	<u><b>MDBT42T</b> – 192K (Chip Antenna)</u> <u><b>MDBT42T</b> – <b>P192K</b> (PCB Antenna)</u>
產品料號 (Part No.)	<u>see <a href="#">4.3 Order Code</a></u>

### Advantage of MDBT42T & MDBT42T-P series:

1. Long working distance:  
**MDBT42T**: over 80 meters in open space.  
**MDBT42T-P**: up to 60 meters in open space.
2. Declaration ID includes all Nordic applied profiles.
3. Granted main regional certification such as FCC (USA), CE(EU)  
TELEC (Japan), SRRC (China), IC (Canada), NCC (Taiwan), and KC (South Korea)

# Index

<b>1. Overall Introduction</b>	<b>4</b>
1.1. Application	4
1.2. Features	5
<b>2. Product Dimension</b>	<b>6</b>
2.1. PCB Dimensions & Pin Indication	6
2.2. Recommended Layout of Solder Pad	8
2.3. RF Layout Suggestion (aka Keep-Out Area)	10
2.4. Footprint & Design Guide	12
2.5. Pin Assignment	13
<b>3. Main Chip Solution</b>	<b>14</b>
<b>4. Shipment Packaging Information</b>	<b>15</b>
4.1. Marking on Metal Shield	16
4.2. Packaging Info	16
4.3. Order Code	18
<b>5. Specification</b>	<b>19</b>
5.1. Absolute Maximum Ratings	19
5.2. Operation Conditions	19
5.3. Electrical Specifications	20
<b>6. Block Diagram</b>	<b>25</b>
<b>7. Antenna</b>	<b>26</b>
7.1. MDBT42T	26
7.2. MDBT42T-P	27
<b>8. Reference Circuit</b>	<b>28</b>
<b>9. Certification</b>	<b>29</b>
9.1. Declaration ID	29
9.2. FCC Certificate (USA)	31
9.3. TELEC Certificate (Japan)	32
9.4. NCC Certificate (Taiwan)	33
9.5. CE (EU) & RCM (Australia & New Zealand) Test Report	35
9.6. IC Certificate (Canada)	37
9.7. SRRC Certificate (China)	38
9.8. KC Certificate (South Korea)	39
9.9. RoHS & REACH Report	40

9.10. End-Product Label.....	40
<b>10. Notes and Cautions.....</b>	<b>42</b>
<b>11. Basic Facts for nRF52 Chip.....</b>	<b>43</b>
<b>12. Useful Links.....</b>	<b>44</b>
<b>Full List of Raytac's BLE Modules.....</b>	<b>45</b>
<b>Release Note.....</b>	<b>49</b>

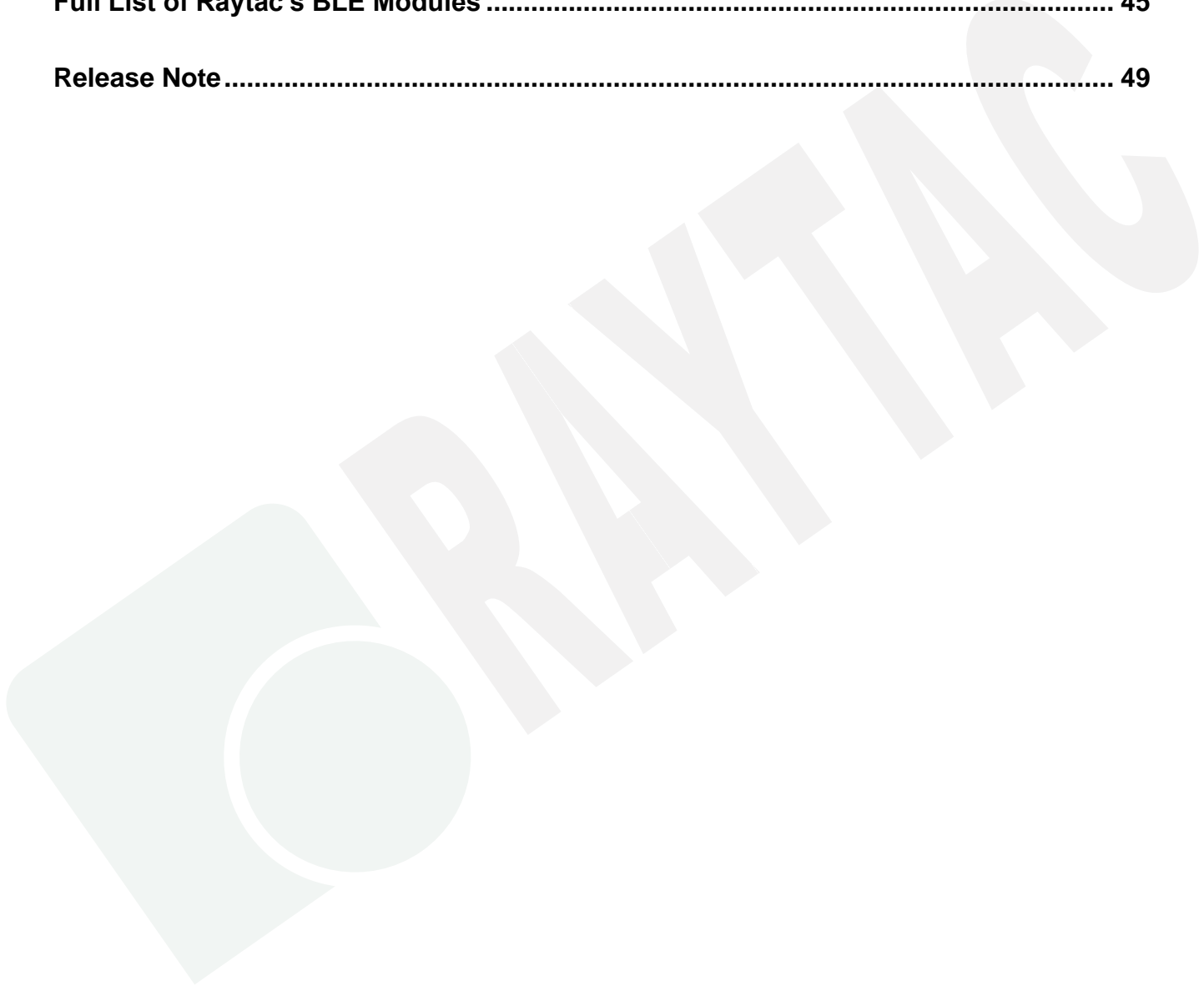

# 1. Overall Introduction

Raytac's MDBT42T-192K & MDBT42T-P192K is a BT 5.1 stack (Bluetooth low energy or BLE) module designed based on **Nordic nRF52805 SoC solution**, which incorporates: **GPIO, SPI, UART, I2C**, and **ADC** interfaces for connecting peripherals and sensors.

Features:

1. Dual Transmission mode of BLE & 2.4Ghz RF upon customer preference.
2. Compact size with **(L) 11.2 x (W) 7.2 x (H) 2.05 or 1.80 mm**.
3. Low power requirements, ultra-low peak, average and idle mode power consumption.
4. Be compatible with a large installed base of mobile phones, tablets and computers.
5. Fully coverage of BLE software stack.
6. BLE & RF transmission switching helps products fit all operation system and most hardware.

## 1.1. Application

- Data bridge
- Proprietary protocol devices
- Network processor
- Beacons
- Smart Home sensors
- Presenters/Stylus
- Health monitoring
- Drug delivery
- Asset tags
- Toys
- Retail tags and labels

## 1.2. Features

- Multi-protocol 2.4GHz radio
- 32-bit ARM Cortex – M4 processor
- 192KB flash programmed memory and 24KB RAM
- Software stacks available as downloads
- Application development independent from protocol stack
- On-air compatible with nRF51, nRF24AP and nRF24L series
- Programmable output power from +4dBm to -20dBm
- RSSI
- RAM mapped FIFOs using EasyDMA
- Flexible and configurable 10 pin GPIO
- Programmable peripheral interface - PPI
- Full set of digital interface all with Easy DMA including:
  - 1 x Hardware SPI master ; 1 x Hardware SPI slave
  - 1 x two-wire master ; 1 x two-wire slave
  - 1 x UART (CTS / RTS)
- 2 channel 12-bit / 200KSPS ADC
- 128-bit AES ECB / CCM / AAR co-processor
- Low power 32MHz crystal and RC oscillators
- Wide supply voltage range 1.7V to 3.6V
- On-chip DC/DC buck converter
- Individual power management for all peripherals
- Timer counter
  - 3x 32-bit
  - 2 x 24-bit RTC

## 2. Product Dimension

### 2.1. PCB Dimensions & Pin Indication

#### • MDBT42T

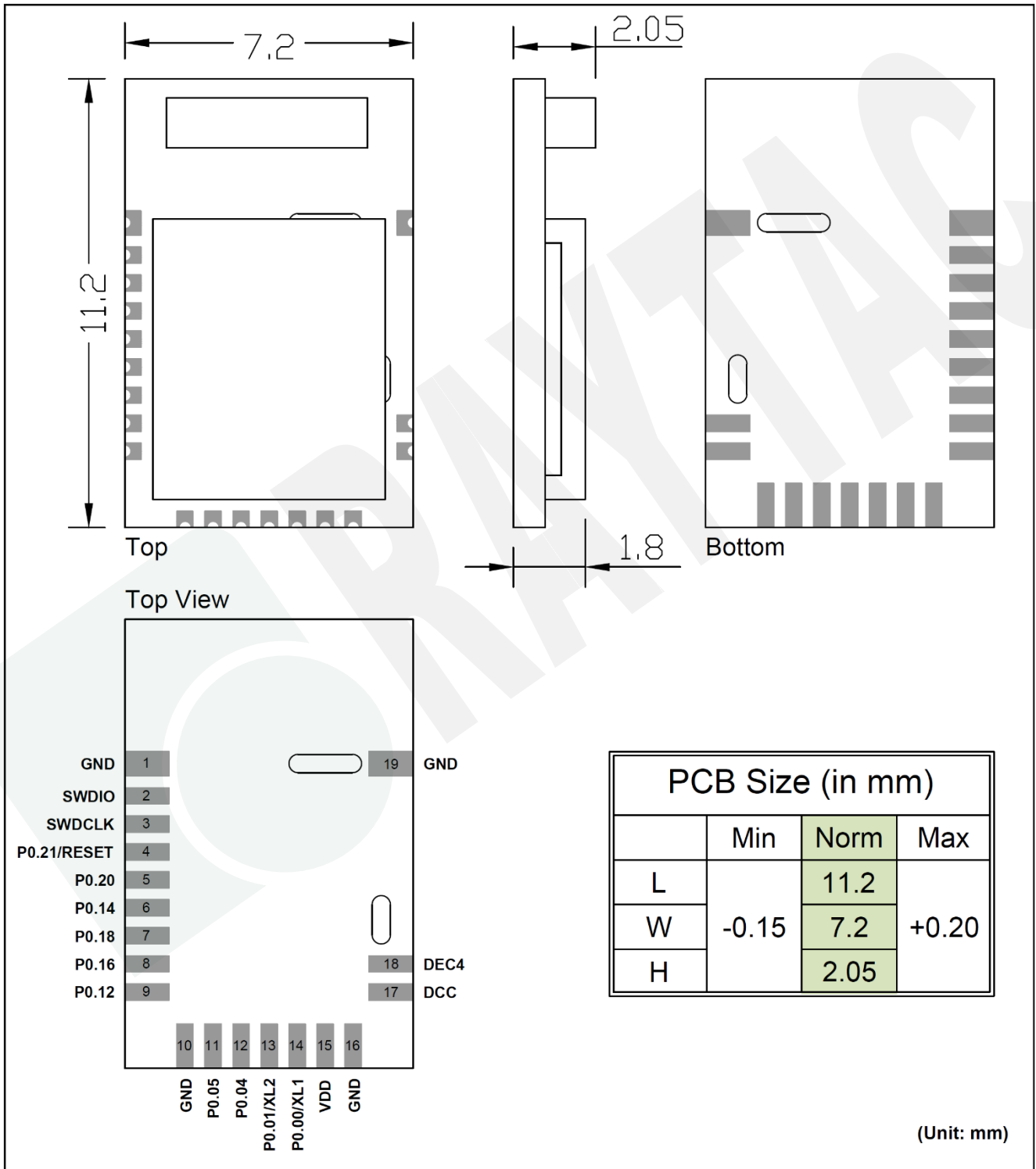

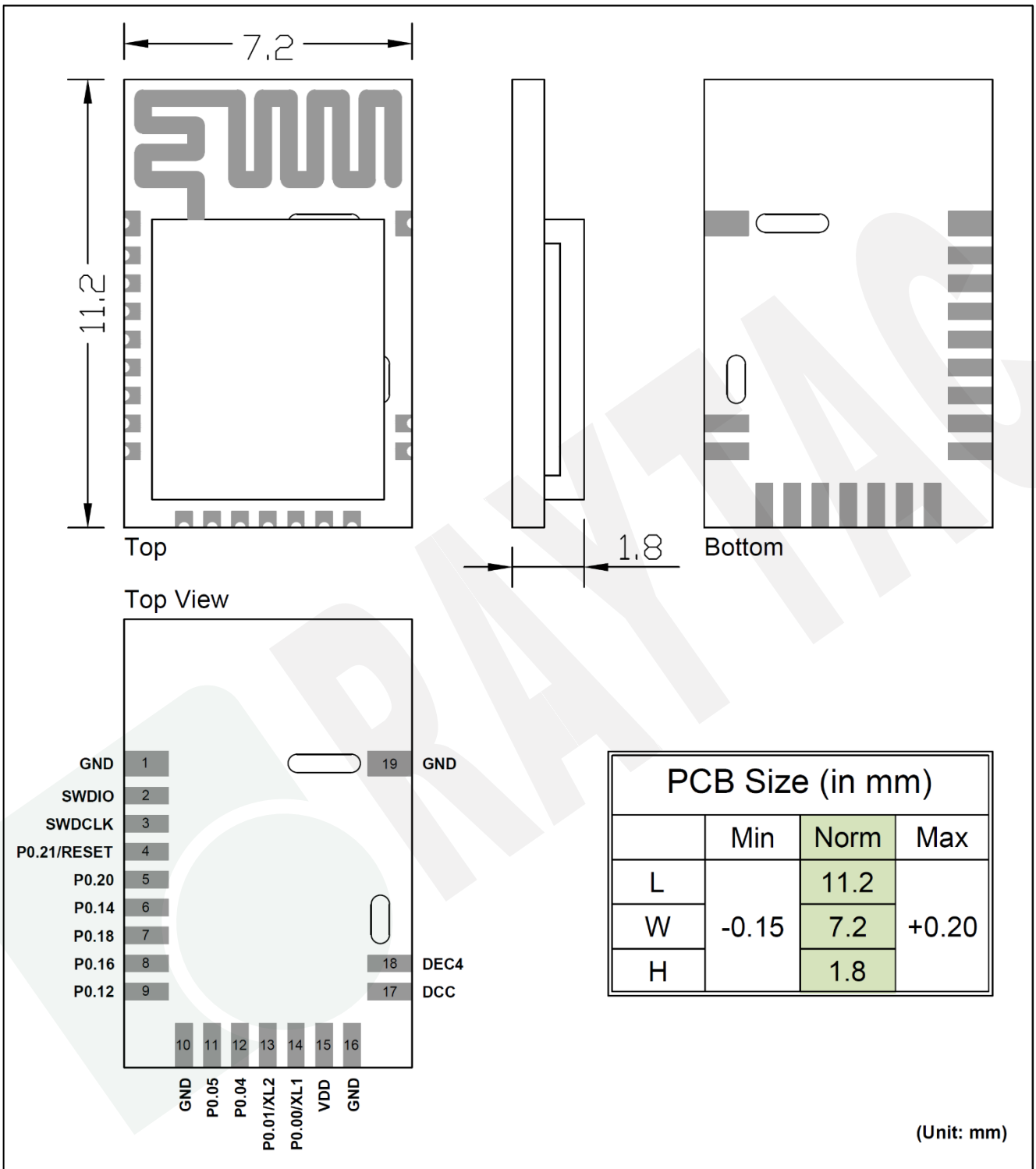

• **MDBT42T-P**



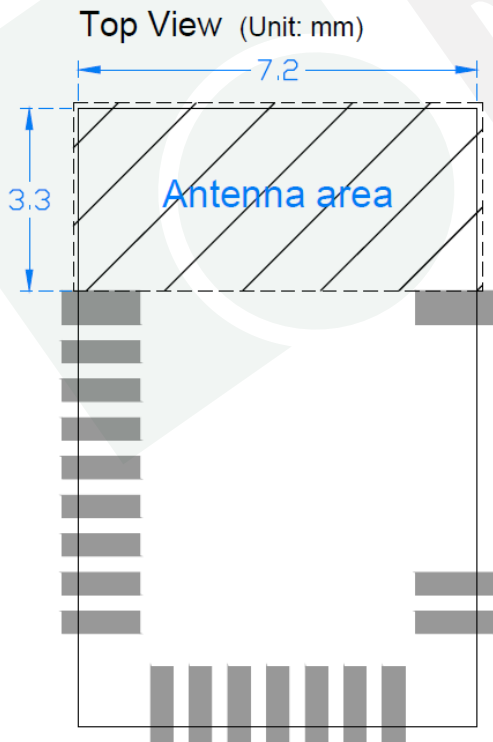
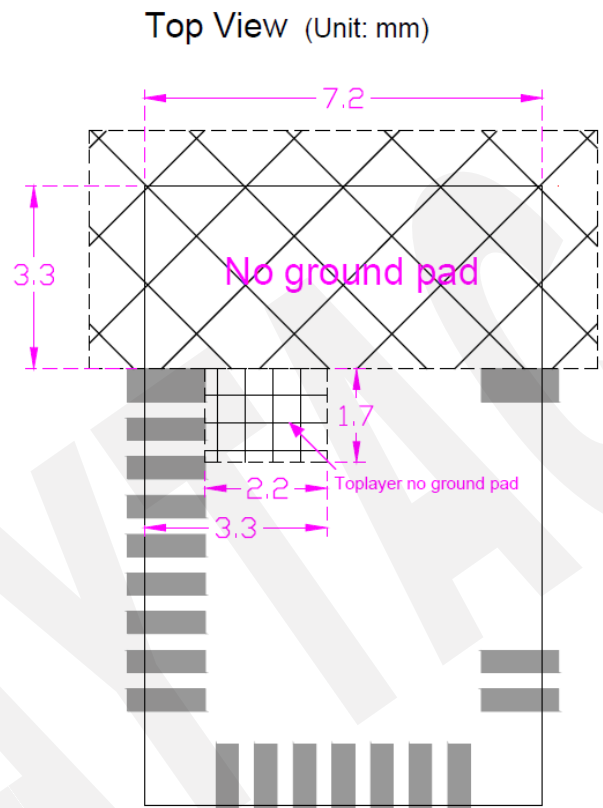
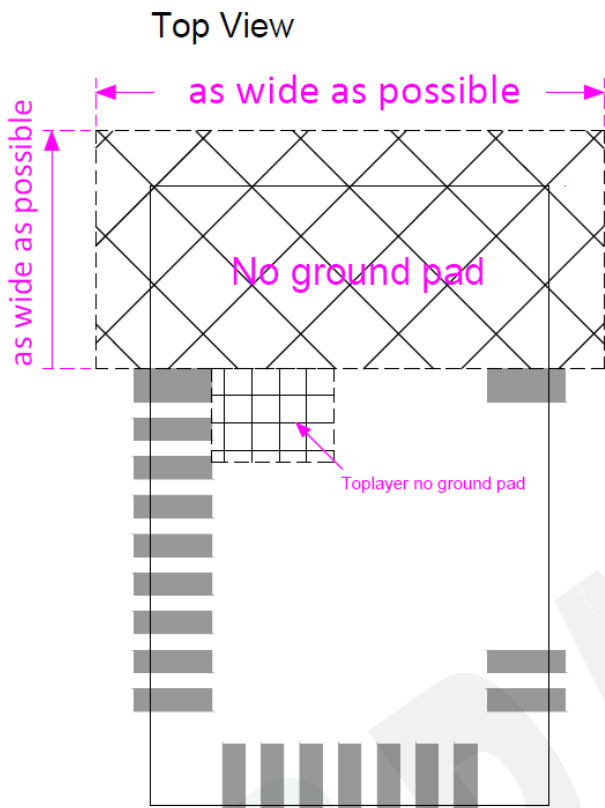

## 2.2. Recommended Layout of Solder Pad

*Graphs are all in Top View, Unit in mm.*



 Antenna area

 No ground pad  
(as wide as possible)

 Toplayer no ground pad



Top View (Unit: mm)

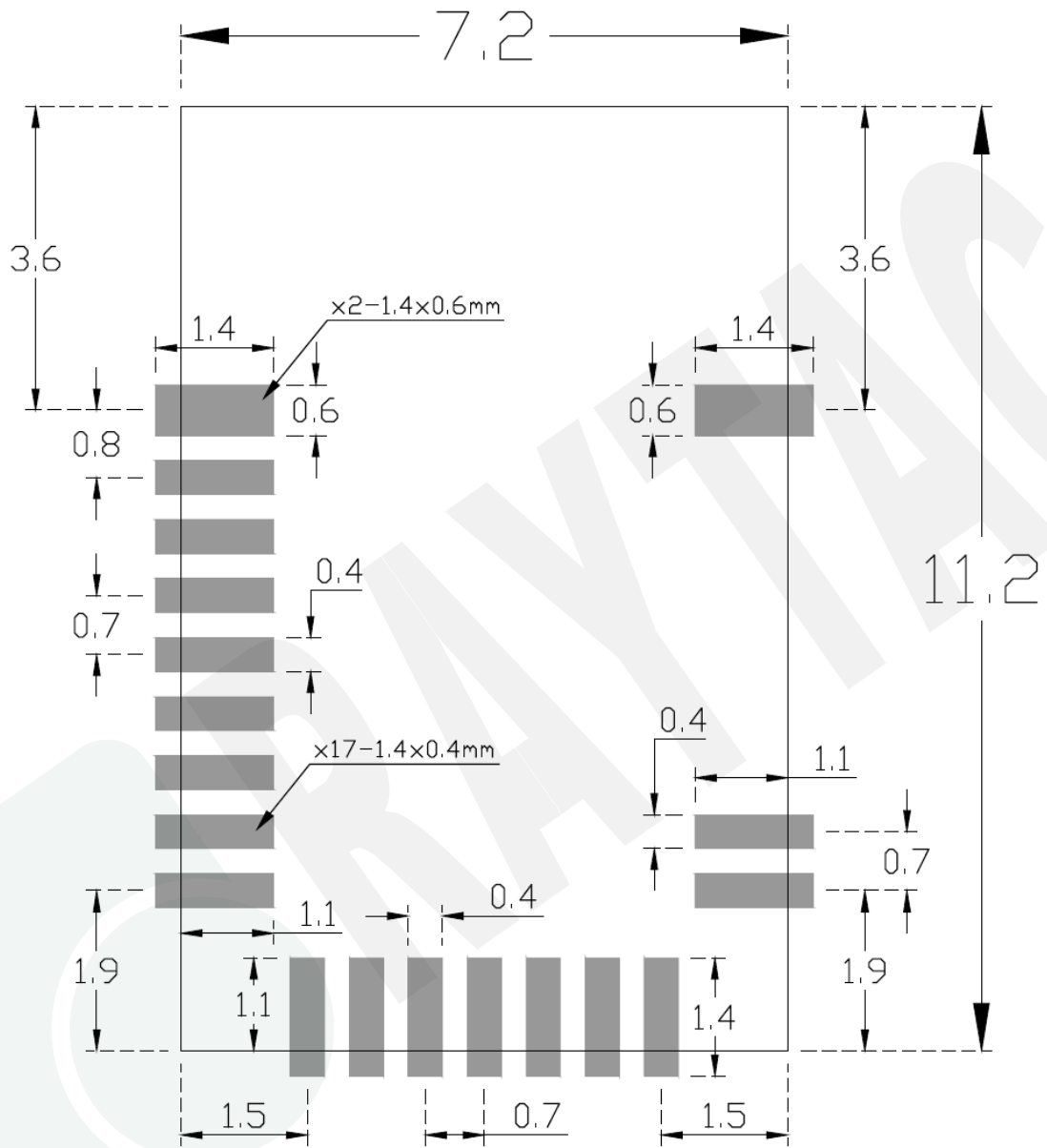

## 2.3. RF Layout Suggestion (aka Keep-Out Area)

Make sure to keep the “No Ground Pad” as wider as you can regardless of the size of your PCB.

No-Ground Pad should be included in the corresponding position of the antenna in **EACH LAYER**.

Place the module towards the edge of PCB to have better performance than placing it on the center.

Welcome to send us your layout in PDF for review at [service@raytac.com](mailto:service@raytac.com) or your contact at Raytac with title “Layout reviewing –Raytac model no.–YOUR company’s name”.

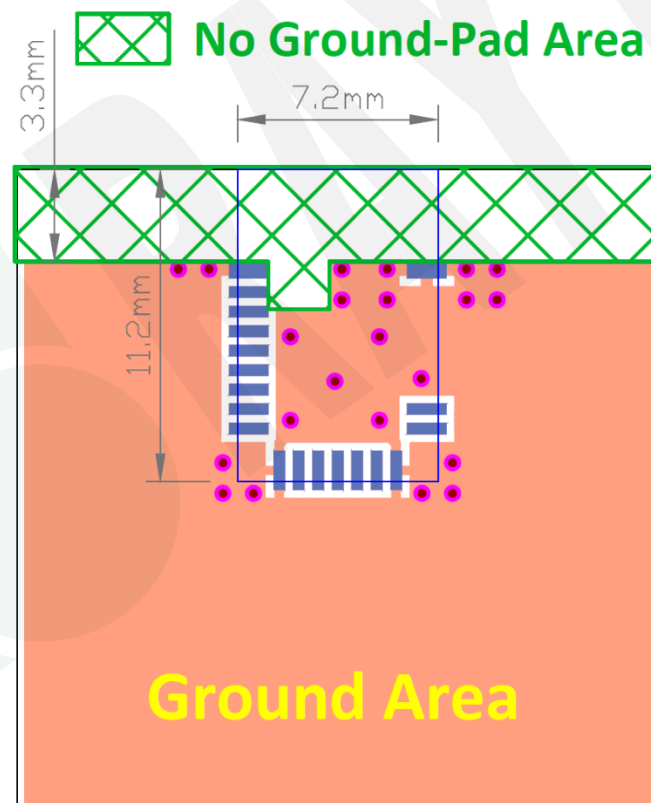

**Top View**

Please add via holes in GROUND area as many as possible, especially around the four corners.

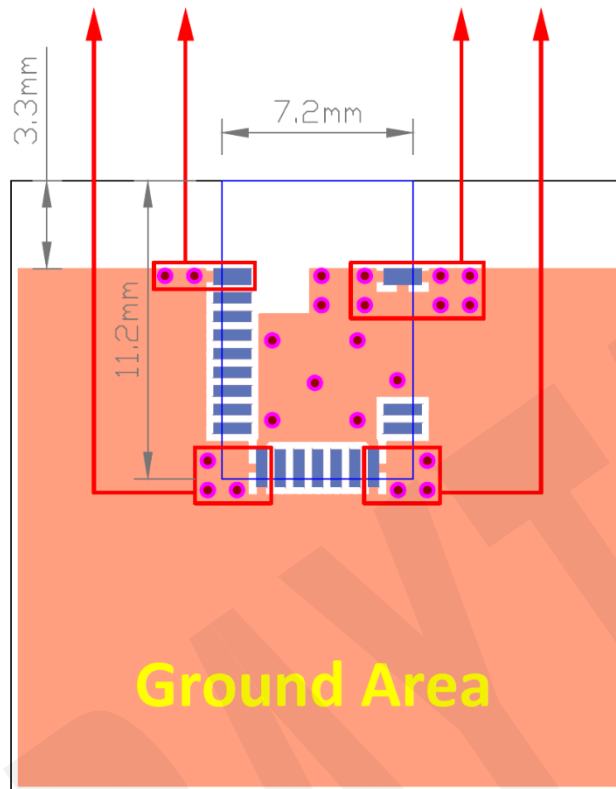

Top View

 No Ground-Pad Area

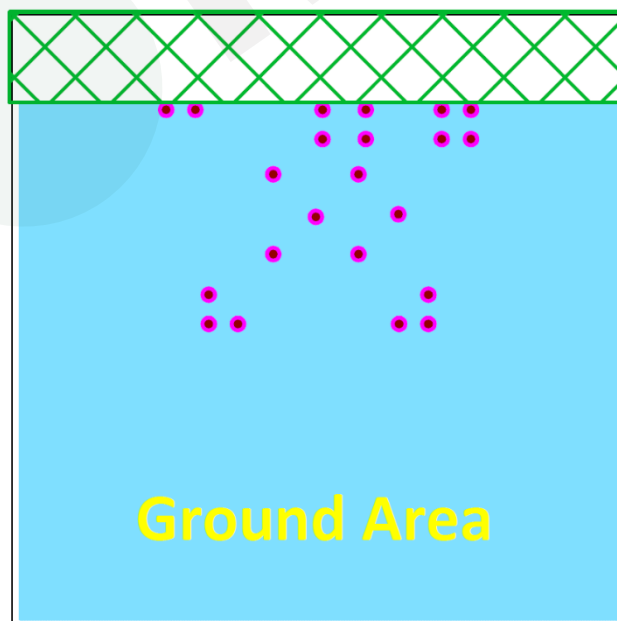

Perspective View

Examples of “**NOT RECOMMENDED**” layout

 where should be NO-GROUND area

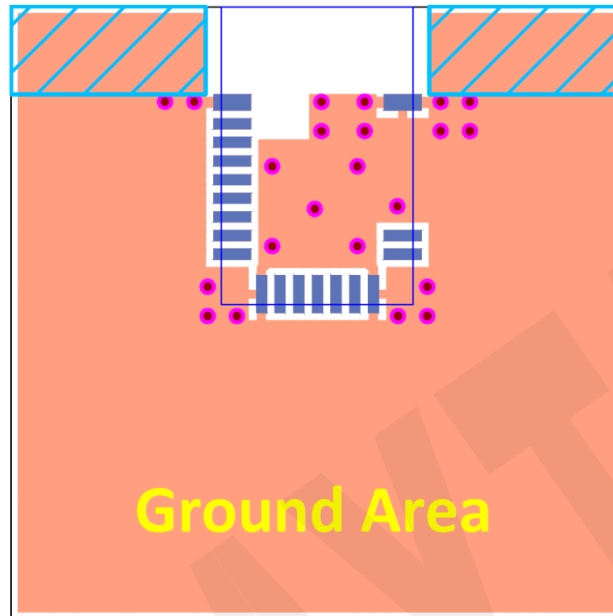

 where should be NO-GROUND area

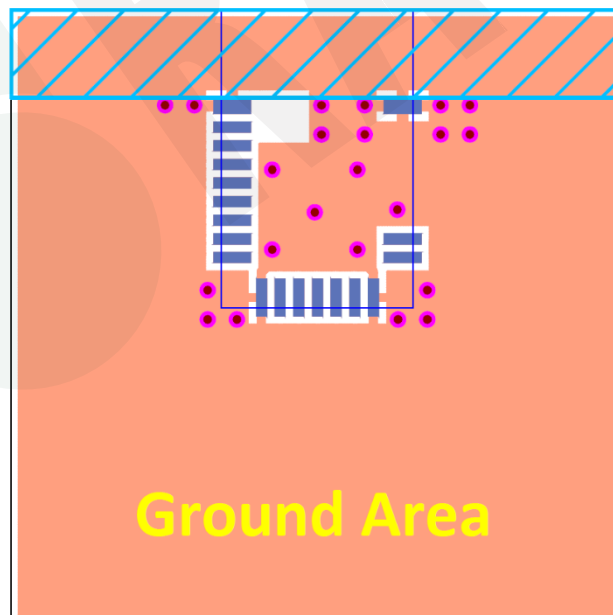

## 2.4. Footprint & Design Guide

Please visit “[Support](#)” page of our website to download. The package includes footprint, 2D/3D drawing, reflow graph and recommended spec for external 32.768khz.

## 2.5. Pin Assignment

Pin No.	Name	Pin function	Description
(1)	<b>GND</b>	Ground	The pad must be connected to a solid ground plane
(2)	<b>SWDIO</b>	Digital I/O	Serial Wire debug I/O for debug and programming
(3)	<b>SWDCLK</b>	Digital input	Serial Wire debug clock input for debug and programming
(4)	<b>P0.21</b>	Digital I/O	General-purpose digital I/O
	<b>RESET</b>		Configurable as system RESET pin
(5)	<b>P0.20</b>	Digital I/O	General-purpose digital I/O
(6)	<b>P0.14</b>	Digital I/O	General-purpose digital I/O
(7)	<b>P0.18</b>	Digital I/O	General-purpose digital I/O
(8)	<b>P0.16</b>	Digital I/O	General-purpose digital I/O
(9)	<b>P0.12</b>	Digital I/O	General-purpose digital I/O
(10)	<b>GND</b>	Ground	The pad must be connected to a solid ground plane
(11)	<b>P0.05</b>	Digital I/O	General-purpose digital I/O
	<b>AIN3</b>	Analog input	SAADC input
(12)	<b>P0.04</b>	Digital I/O	General-purpose digital I/O
	<b>AIN2</b>	Analog input	SAADC input
(13)	<b>P0.01</b>	Digital I/O	General-purpose digital I/O
	<b>XL2</b>	Analog input	Connection to 32.768khz crystal (LFXO)
(14)	<b>P0.00</b>	Digital I/O	General-purpose digital I/O
	<b>XL1</b>	Analog input	Connection to 32.768khz crystal (LFXO)
(15)	<b>VDD</b>	Power	Power-supply pin
(16)	<b>GND</b>	Ground	The pad must be connected to a solid ground plane
(17)	<b>DCC</b>	Power	DC/DC converter output pin
(18)	<b>DEC4</b>	Power	1V3 regulator supply decoupling. Input from DC/DC converter. Output from 1V3 LDO
(19)	<b>GND</b>	Ground	The pad must be connected to a solid ground plane



### 3. Main Chip Solution

RF IC	Crystal Frequency
Nordic NRF52805	32MHZ

*32MHz crystal is already inside the module.*



## 4. Shipment Packaging Information

Model	Antenna	Photo
MDBT42T-192K	Chip/Ceramic	
MDBT42T-P192K	PCB/Printed	

- Unit Weight of Module:

MDBT42T-192K: 0.28 g ( $\pm 0.02$  g) ; MDBT42T-P192K: 0.26 g ( $\pm 0.02$  g)

- Packaging Type: Tray or Tape & Reel

	Tray	Tape & Reel (13")
<b>MPQ (Min. Package Q'ty)</b>	120 pcs per tray	2,000 pcs per reel
<b>Carton Contents (per carton)</b>	2,400 pcs	2,000 pcs
<b>Carton Dimension (L) x (W) x (H) cm</b>	37 x 21 x 13	37 x 36 x 6
<b>Gross Weight</b>	about 2.2 kgs	about 1.6 kgs

## 4.1. Marking on Metal Shield

Label context on metal shield is as below:

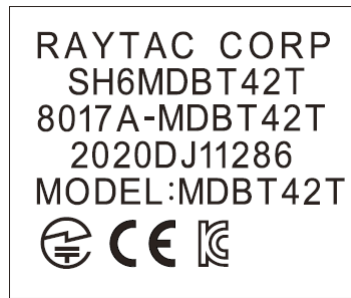

## 4.2. Packaging Info

### 4.2.1. Tray Packaging

Anti-static tray is specifically designed for mass production. It can be used directly on SMT automatic machine.

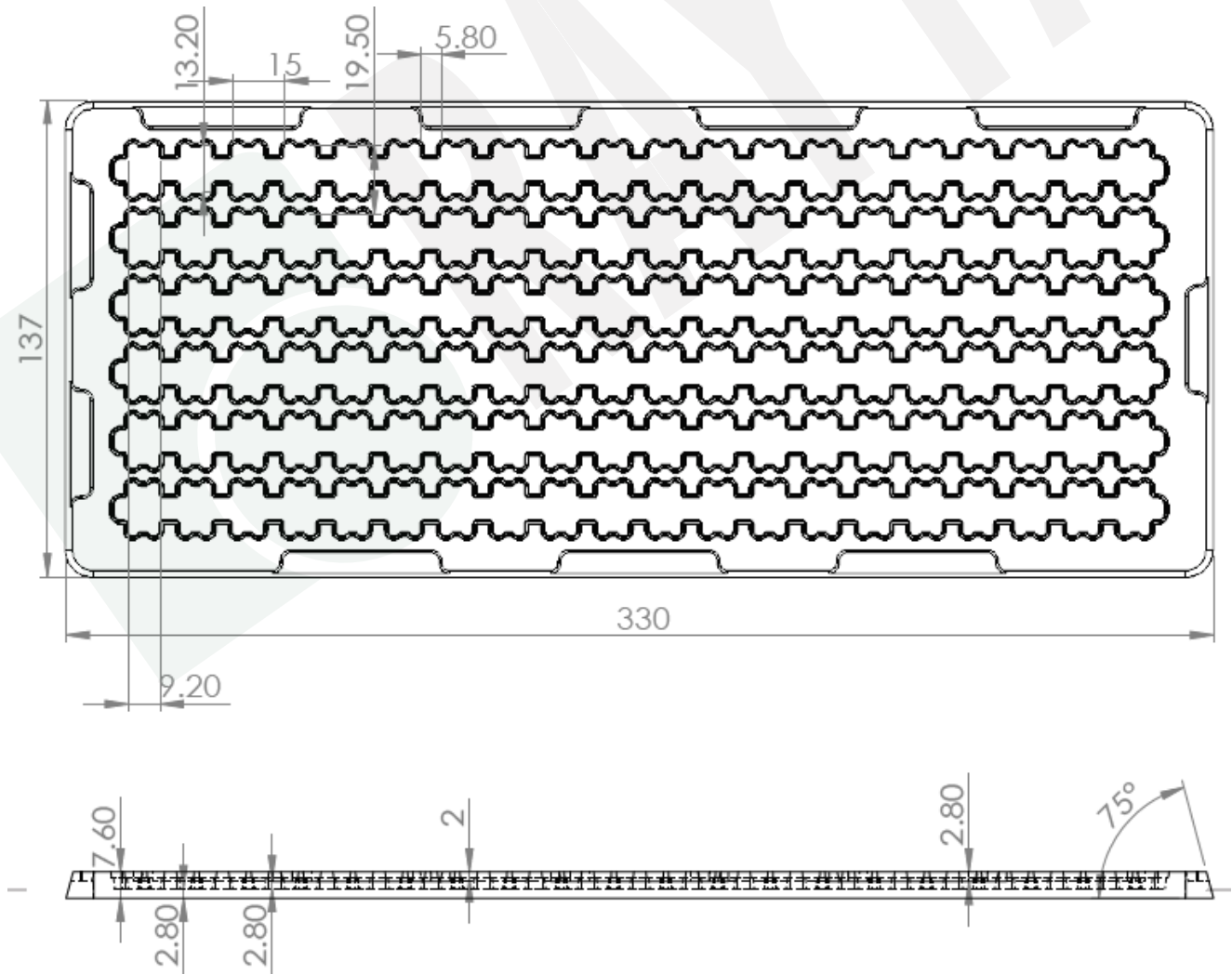



## 4.2.2. Tape & Reel Packaging

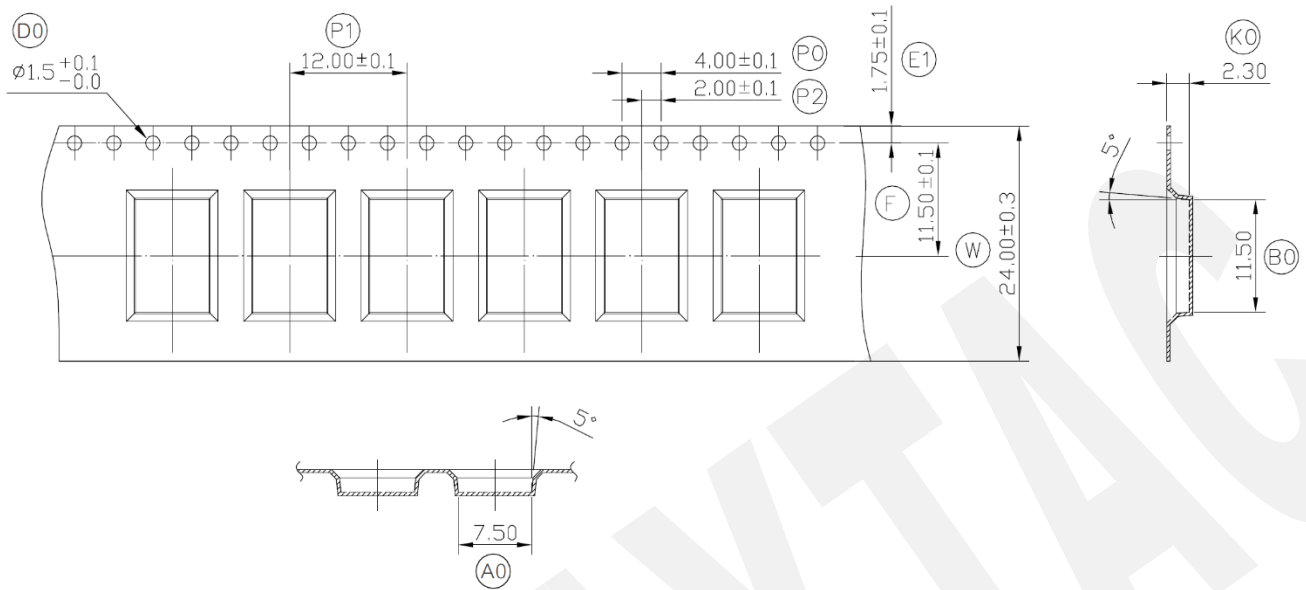

W	<b>24.00</b>	$\pm 0.30$
P1	<b>12.00</b>	$\pm 0.10$
E1	<b>1.75</b>	$\pm 0.10$
F	<b>11.50</b>	$\pm 0.10$
D0	<b>1.50</b>	$+0.1/-0$
P0	<b>4.00</b>	$\pm 0.10$
P2	<b>2.00</b>	$\pm 0.10$
A0	<b>7.50</b>	$\pm 0.10$
B0	<b>11.50</b>	$\pm 0.10$
K0	<b>2.30</b>	$\pm 0.10$
T	<b>0.35</b>	$\pm 0.05$

### 4.3. Order Code

Each model has two options of packaging. Please use following part no. when placing order to us.

<b>Model</b>	<b>Tray</b>	<b>Tape &amp; Reel</b>
MDBT42T-192K	MD-240A5-001	MD-240A5-001R
MDBT42T-P192K	MD-240A5-002	MD-240A5-002R

*MPQ of Reel packaging is 2,000 pcs and Tray packaging is 120 pcs.*

## 5. Specification

Any technical spec shall refer to Nordic's official documents as final reference. Contents below are from "[nRF52805 Product Specification v1.4](#)", please click to download full spec.

### 5.1. Absolute Maximum Ratings

	Note	Min.	Max.	Unit
<b>Supply voltages</b>				
VDD		-0.3	+3.9	V
VSS			0	V
<b>I/O pin voltage</b>				
$V_{I/O}$ , VDD $\leq$ 3.6 V		-0.3	VDD + 0.3	V
$V_{I/O}$ , VDD > 3.6 V		-0.3	3.9	V
<b>Environmental WLCSP package</b>				
Storage temperature		-40	+125	°C
MSL	Moisture Sensitivity Level		1	
ESD HBM	Human Body Model		3	kV
ESD HBM Class	Human Body Model Class		2	
ESD CDM	Charged Device Model		1	kV
<b>Flash memory</b>				
Endurance		10 000		write/erase cycles
Retention at 85 °C		10		years

### 5.2. Operation Conditions

Symbol	Parameter	Min.	Nom.	Max.	Units
VDD	Supply voltage, independent of DCDC enable	1.7	3.0	3.6	V
$t_{R\_VDD}$	Supply rise time (0 V to 1.7 V)			60	ms
TA	Operating temperature	-40	25	85	°C

Important: The on-chip power-on reset circuitry may not function properly for rise times longer than the specified maximum.

## 5.3. Electrical Specifications

### 5.3.1. General Radio Characteristics

Symbol	Description	Min.	Typ.	Max.	Units
$f_{OP}$	Operating frequencies	2360		2500	MHz
$f_{PLL,CH,SP}$	PLL channel spacing		1		MHz
$f_{DELTA,1M}$	Frequency deviation @ 1 Mbps		$\pm 170$		kHz
$f_{DELTA,BLE,1M}$	Frequency deviation @ BLE 1 Mbps		$\pm 250$		kHz
$f_{DELTA,2M}$	Frequency deviation @ 2 Mbps		$\pm 320$		kHz
$f_{DELTA,BLE,2M}$	Frequency deviation @ BLE 2 Mbps		$\pm 500$		kHz
$fsk_{BPS}$	On-the-air data rate	1000		2000	kbps

### 5.3.2. Radio Current Consumption (Transmitter)

Symbol	Description	Min.	Typ.	Max.	Units
$I_{TX,PLUS4dBm,DCDC}$	TX only run current (DCDC, 3V) $P_{RF} = +4$ dBm		7.0		mA
$I_{TX,PLUS4dBm}$	TX only run current $P_{RF} = +4$ dBm		15.4		mA
$I_{TX,0dBm,DCDC}$	TX only run current (DCDC, 3V) $P_{RF} = 0$ dBm		4.6		mA
$I_{TX,0dBm}$	TX only run current $P_{RF} = 0$ dBm		10.1		mA
$I_{TX,MINUS4dBm,DCDC}$	TX only run current DCDC, 3V $P_{RF} = -4$ dBm		3.6		mA
$I_{TX,MINUS4dBm}$	TX only run current $P_{RF} = -4$ dBm		7.8		mA
$I_{TX,MINUS8dBm,DCDC}$	TX only run current DCDC, 3V $P_{RF} = -8$ dBm		3.2		mA
$I_{TX,MINUS8dBm}$	TX only run current $P_{RF} = -8$ dBm		6.8		mA
$I_{TX,MINUS12dBm,DCDC}$	TX only run current DCDC, 3V $P_{RF} = -12$ dBm		2.9		mA
$I_{TX,MINUS12dBm}$	TX only run current $P_{RF} = -12$ dBm		6.2		mA
$I_{TX,MINUS16dBm,DCDC}$	TX only run current DCDC, 3V $P_{RF} = -16$ dBm		2.7		mA
$I_{TX,MINUS16dBm}$	TX only run current $P_{RF} = -16$ dBm		5.7		mA
$I_{TX,MINUS20dBm,DCDC}$	TX only run current DCDC, 3V $P_{RF} = -20$ dBm		2.5		mA
$I_{TX,MINUS20dBm}$	TX only run current $P_{RF} = -20$ dBm		5.4		mA
$I_{TX,MINUS40dBm,DCDC}$	TX only run current DCDC, 3V $P_{RF} = -40$ dBm		2.1		mA
$I_{TX,MINUS40dBm}$	TX only run current $P_{RF} = -40$ dBm		4.3		mA

### 5.3.3. Radio Current Consumption (Receiver)

Symbol	Description	Min.	Typ.	Max.	Units
$I_{RX,1M,DCDC}$	RX only run current (DC/DC, 3 V) 1 Mbps/1 Mbps BLE		4.6		mA
$I_{RX,1M}$	RX only run current (LDO, 3 V) 1 Mbps/1 Mbps BLE		10.0		mA
$I_{RX,2M,DCDC}$	RX only run current (DC/DC, 3 V) 2 Mbps/2 Mbps BLE		5.2		mA
$I_{RX,2M}$	RX only run current (LDO, 3 V) 2 Mbps/2 Mbps BLE		11.2		mA
$I_{START,RX,1M,DCDC}$	RX start-up current (DC/DC, 3 V) 1 Mbps/1 Mbps BLE		3.5		mA
$I_{START,RX,1M}$	RX start-up current 1 Mbps/1 Mbps BLE		6.7		mA

### 5.3.4. Transmitter Specification

Symbol	Description	Min.	Typ.	Max.	Units
$P_{RF}$	Maximum output power		4		dBm
$P_{RFC}$	RF power control range		24		dB
$P_{RFCR}$	RF power accuracy			$\pm 4$	dB
$P_{RF1,1}$	1st Adjacent Channel Transmit Power 1 MHz (1 Mbps)		-25		dBc
$P_{RF2,1}$	2nd Adjacent Channel Transmit Power 2 MHz (1 Mbps)		-50		dBc
$P_{RF1,2}$	1st Adjacent Channel Transmit Power 2 MHz (2 Mbps)		-25		dBc
$P_{RF2,2}$	2nd Adjacent Channel Transmit Power 4 MHz (2 Mbps)		-50		dBc

### 5.3.5. Receiver Operation

Symbol	Description	Min.	Typ.	Max.	Units
$P_{RX,MAX}$	Maximum received signal strength at < 0.1% PER		0		dBm
$P_{SENS,IT,1M}$	Sensitivity, 1 Mbps nRF mode ideal transmitter <sup>1</sup>		-94		dBm
$P_{SENS,IT,2M}$	Sensitivity, 2 Mbps nRF mode ideal transmitter <sup>1</sup>		-91		dBm
$P_{SENS,IT,SP,1M,BLE}$	Sensitivity, 1 Mbps BLE ideal transmitter, packet length $\leq 37$ bytes BER= $1E-3$ <sup>2</sup>		-97		dBm
$P_{SENS,IT,LP,1M,BLE}$	Sensitivity, 1 Mbps BLE ideal transmitter, packet length $\geq 128$ bytes BER= $1E-4$ <sup>3</sup>		-96		dBm
$P_{SENS,IT,SP,2M,BLE}$	Sensitivity, 2 Mbps BLE ideal transmitter, packet length $\leq 37$ bytes		-94		dBm

1. Typical sensitivity applies when ADDR0 is used for receiver address correlation. When ADDR [1...7] are used for receiver address correlation, the typical sensitivity for this mode is degraded by 3dB.
2. As defined in the Bluetooth Core Specification v4.0 Volume 6: Core System Package (Low Energy Controller Volume).
3. Equivalent BER limit < 10E-04.

## 5.3.6. RX Selectivity

Symbol	Description	Min.	Typ.	Max.	Units
C/I <sub>1M,co-channel</sub>	1Mbps mode, co-channel interference		9		dB
C/I <sub>1M,-1MHz</sub>	1 Mbps mode, Adjacent (-1 MHz) interference		-2		dB
C/I <sub>1M,+1MHz</sub>	1 Mbps mode, Adjacent (+1 MHz) interference		-10		dB
C/I <sub>1M,-2MHz</sub>	1 Mbps mode, Adjacent (-2 MHz) interference		-19		dB
C/I <sub>1M,+2MHz</sub>	1 Mbps mode, Adjacent (+2 MHz) interference		-42		dB
C/I <sub>1M,-3MHz</sub>	1 Mbps mode, Adjacent (-3 MHz) interference		-38		dB
C/I <sub>1M,+3MHz</sub>	1 Mbps mode, Adjacent (+3 MHz) interference		-48		dB
C/I <sub>1M,±6MHz</sub>	1 Mbps mode, Adjacent (≥6 MHz) interference		-50		dB
C/I <sub>1MBLE,co-channel</sub>	1 Mbps BLE mode, co-channel interference		6		dB
C/I <sub>1MBLE,-1MHz</sub>	1 Mbps BLE mode, Adjacent (-1 MHz) interference		-2		dB
C/I <sub>1MBLE,+1MHz</sub>	1 Mbps BLE mode, Adjacent (+1 MHz) interference		-9		dB
C/I <sub>1MBLE,-2MHz</sub>	1 Mbps BLE mode, Adjacent (-2 MHz) interference		-22		dB
C/I <sub>1MBLE,+2MHz</sub>	1 Mbps BLE mode, Adjacent (+2 MHz) interference		-46		dB
C/I <sub>1MBLE,&gt;3MHz</sub>	1 Mbps BLE mode, Adjacent (≥3 MHz) interference		-50		dB
C/I <sub>1MBLE,image</sub>	Image frequency interference		-22		dB
C/I <sub>1MBLE,image,1MHz</sub>	Adjacent (1 MHz) interference to in-band image frequency		-35		dB
C/I <sub>2M,co-channel</sub>	2 Mbps mode, co-channel interference		10		dB
C/I <sub>2M,-2MHz</sub>	2 Mbps mode, Adjacent (-2 MHz) interference		6		dB
C/I <sub>2M,+2MHz</sub>	2 Mbps mode, Adjacent (+2 MHz) interference		-14		dB
C/I <sub>2M,-4MHz</sub>	2 Mbps mode, Adjacent (-4 MHz) interference		-20		dB
C/I <sub>2M,+4MHz</sub>	2 Mbps mode, Adjacent (+4 MHz) interference		-44		dB
C/I <sub>2M,-6MHz</sub>	2 Mbps mode, Adjacent (-6 MHz) interference		-42		dB
C/I <sub>2M,+6MHz</sub>	2 Mbps mode, Adjacent (+6 MHz) interference		-47		dB
C/I <sub>2M,≥12MHz</sub>	2 Mbps mode, Adjacent (≥12 MHz) interference		-52		dB
C/I <sub>2MBLE,co-channel</sub>	2 Mbps BLE mode, co-channel interference		6		dB
C/I <sub>2MBLE,-2MHz</sub>	2 Mbps BLE mode, Adjacent (-2 MHz) interference		-2		dB
C/I <sub>2MBLE,+2MHz</sub>	2 Mbps BLE mode, Adjacent (+2 MHz) interference		-12		dB
C/I <sub>2MBLE,-4MHz</sub>	2 Mbps BLE mode, Adjacent (-4 MHz) interference		-22		dB
C/I <sub>2MBLE,+4MHz</sub>	2 Mbps BLE mode, Adjacent (+4 MHz) interference		-46		dB
C/I <sub>2MBLE,≥6MHz</sub>	2 Mbps BLE mode, Adjacent (≥6 MHz) interference		-50		dB
C/I <sub>2MBLE,image</sub>	Image frequency interference		-29		dB
C/I <sub>2MBLE,image, 2MHz</sub>	Adjacent (2 MHz) interference to in-band image frequency		-44		dB

Remark: Wanted signal level at PIN = -67 dBm. One interferer is used, having equal modulation as the wanted signal. The input power of the interferer where the sensitivity equals BER = 0.1% is presented.

## 5.3.7. RX Intermodulation

Symbol	Description	Min.	Typ.	Max.	Units
P <sub>IMD,5TH,1M</sub>	IMD performance, 1 Msps, 5th offset channel, Packet length <= 37 bytes		-33		dBm
P <sub>IMD,5TH,1M,BLE</sub>	IMD performance, BLE 1 Msps, 5th offset channel, Packet length <= 37 bytes		-30		dBm
P <sub>IMD,5TH,2M</sub>	IMD performance, 2 Msps, 5th offset channel, Packet length <= 37 bytes		-33		dBm
P <sub>IMD,5TH,2M,BLE</sub>	IMD performance, BLE 2 Msps, 5th offset channel, Packet length <= 37 bytes		-31		dBm

Remark: Wanted signal level at PIN = -64dBm. Two interferers with equal input power are used. The interferer closest in frequency is not modulated, the other interferer is modulated equal with the wanted signal. The input power of the interferers where the sensitivity equals BER = 0.1% is presented.

## 5.3.8. Radio Timing Parameters

Symbol	Description	Min.	Typ.	Max.	Units
t <sub>TXEN,BLE,1M</sub>	Time between TXEN task and READY event after channel FREQUENCY configured (1 Mbps BLE and 150 μs TIFS)		140		μs
t <sub>TXEN,FAST,BLE,1M</sub>	Time between TXEN task and READY event after channel FREQUENCY configured (1 Mbps BLE with fast ramp-up and 150 μs TIFS)		40		μs
t <sub>TXDIS,BLE,1M</sub>	When in TX, delay between DISABLE task and DISABLED event for MODE = Nrf_1Mbit and MODE = Ble_1Mbit		6		μs
t <sub>RXEN,BLE,1M</sub>	Time between the RXEN task and READY event after channel FREQUENCY configured (1 Mbps BLE)		140		μs
t <sub>RXEN,FAST,BLE,1M</sub>	Time between the RXEN task and READY event after channel FREQUENCY configured (1 Mbps BLE with fast ramp-up)		40		μs
t <sub>RXDIS,BLE,1M</sub>	When in RX, delay between DISABLE task and DISABLED event for MODE = Nrf_1Mbit and MODE = Ble_1Mbit		0		μs
t <sub>TXDIS,BLE,2M</sub>	When in TX, delay between DISABLE task and DISABLED event for MODE = Nrf_2Mbit and MODE = Ble_2Mbit		4		μs
t <sub>RXDIS,BLE,2M</sub>	When in RX, delay between DISABLE task and DISABLED event for MODE = Nrf_2Mbit and MODE = Ble_2Mbit		0		μs



### 5.3.9. RSSI Specifications

Symbol	Description	Min.	Typ.	Max.	Units
RSSI <sub>ACC</sub>	RSSI accuracy <sup>18</sup>		±2		dB
RSSI <sub>RESOLUTION</sub>	RSSI resolution		1		dB
RSSI <sub>PERIOD</sub>	RSSI sampling time from RSSI_START task		0.25		µs
RSSI <sub>SETTLE</sub>	RSSI settling time after signal level change		15		µs

### 5.3.10. CPU

Symbol	Description	Min.	Typ.	Max.	Units
W <sub>FLASH</sub>	CPU wait states, running from flash	0		2	
W <sub>RAM</sub>	CPU wait states, running from RAM			0	
CM <sub>FLASH</sub>	CoreMark <sup>1</sup> , running from flash		144		CoreMark
CM <sub>FLASH/MHz</sub>	CoreMark per MHz, running from flash		2.25		CoreI MHz
CM <sub>FLASH/mA</sub>	CoreMark per mA, running from flash, DCDC 3V		65		CoreMark/mA

### 5.3.11. Power Management

Symbol	Description	Min.	Typ.	Max.	Units
I <sub>ON_RAMOFF_EVENT</sub>	System ON, no RAM retention, wake on any event		0.6		µA
I <sub>ON_RAMON_EVENT</sub>	System ON, full 24 kB RAM retention, wake on any event		0.8		µA
I <sub>ON_RAMON_POF</sub>	System ON, full 24 kB RAM retention, wake on any event, power-fail comparator enabled		0.8		µA
I <sub>ON_RAMON_GPIOTE</sub>	System ON, full 24 kB RAM retention, wake on GPIOTE input (event mode)		3.3		µA
I <sub>ON_RAMON_GPIOTEPORT</sub>	System ON, full 24 kB RAM retention, wake on GPIOTE PORT event		0.8		µA
I <sub>ON_RAMOFF_RTC</sub>	System ON, no RAM retention, wake on RTC (running from LFRC clock)		1.4		µA
I <sub>ON_RAMON_RTC</sub>	System ON, full 24 kB RAM retention, wake on RTC (running from LFRC clock)		1.5		µA
I <sub>OFF_RAMOFF_RESET</sub>	System OFF, no RAM retention, wake on reset		0.3		µA
I <sub>OFF_RAMON_RESET</sub>	System OFF, full 24 kB RAM retention, wake on reset		0.5		µA
I <sub>ON_RAMON_RTC_LFXO</sub>	System ON, full 24 kB RAM retention, wake on RTC (running from LFXO clock)		1.1		µA
I <sub>ON_RAMOFF_RTC_LFXO</sub>	System ON, no RAM retention, wake on RTC (running from LFXO clock)		1.0		µA



# 6. Block Diagram

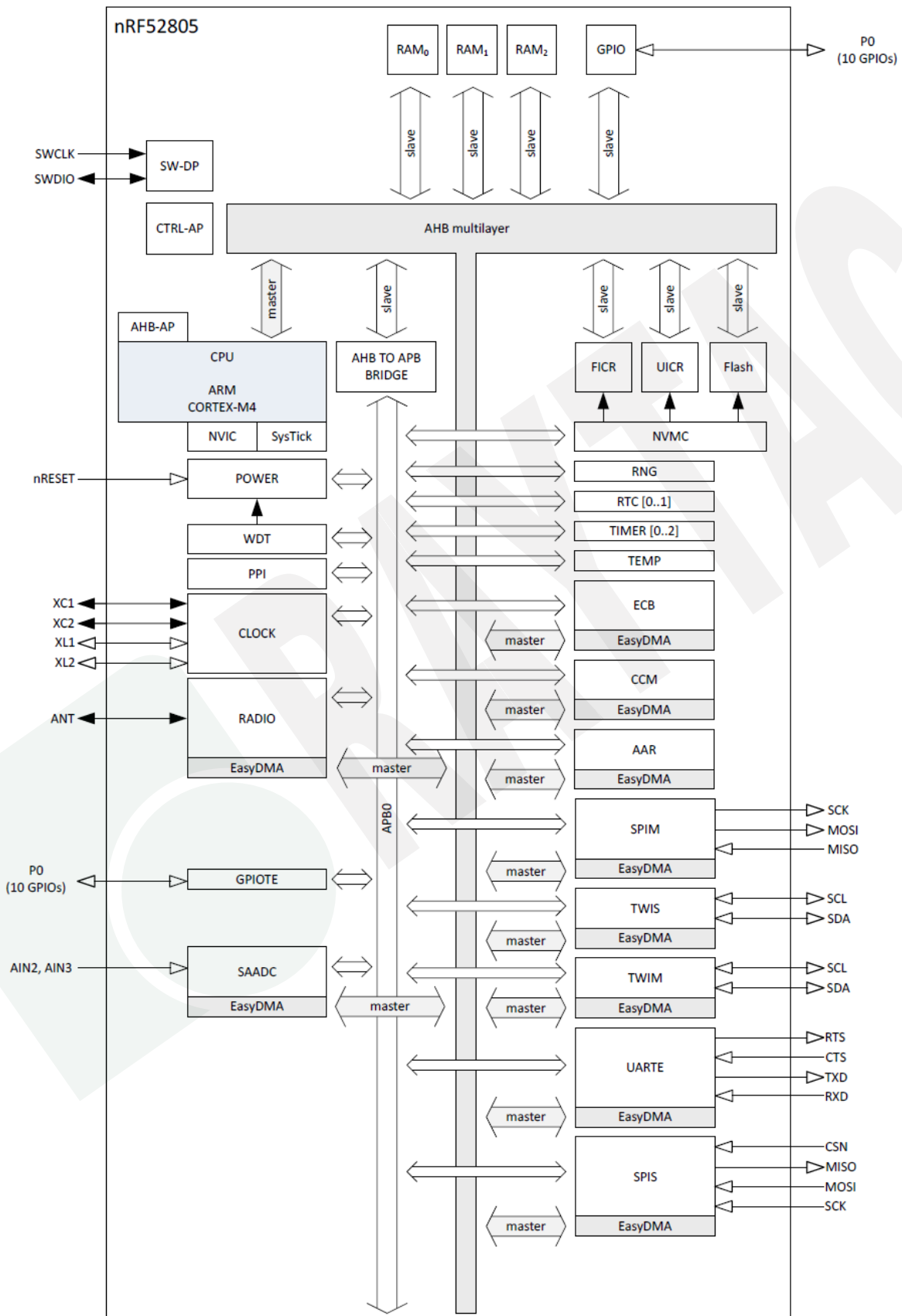

# 7. Antenna

## 7.1. MDBT42T

### Test Result

Frequency (MHz)	2400	2410	2420	2430	2440	2450	2460	2470	2480	2490	2500
Gain (dBi)	-2.09	-1.70	-1.52	-1.66	-1.72	-1.98	-2.41	-2.86	-3.42	-4.01	-4.67
Directivity (dBi)	5.30	5.29	5.23	5.25	5.28	5.22	5.13	5.05	4.98	4.91	4.86
Efficiency (dB)	-7.38	-7.00	-6.76	-6.90	-7.00	-7.20	-7.54	-7.91	-8.40	-8.93	-9.53

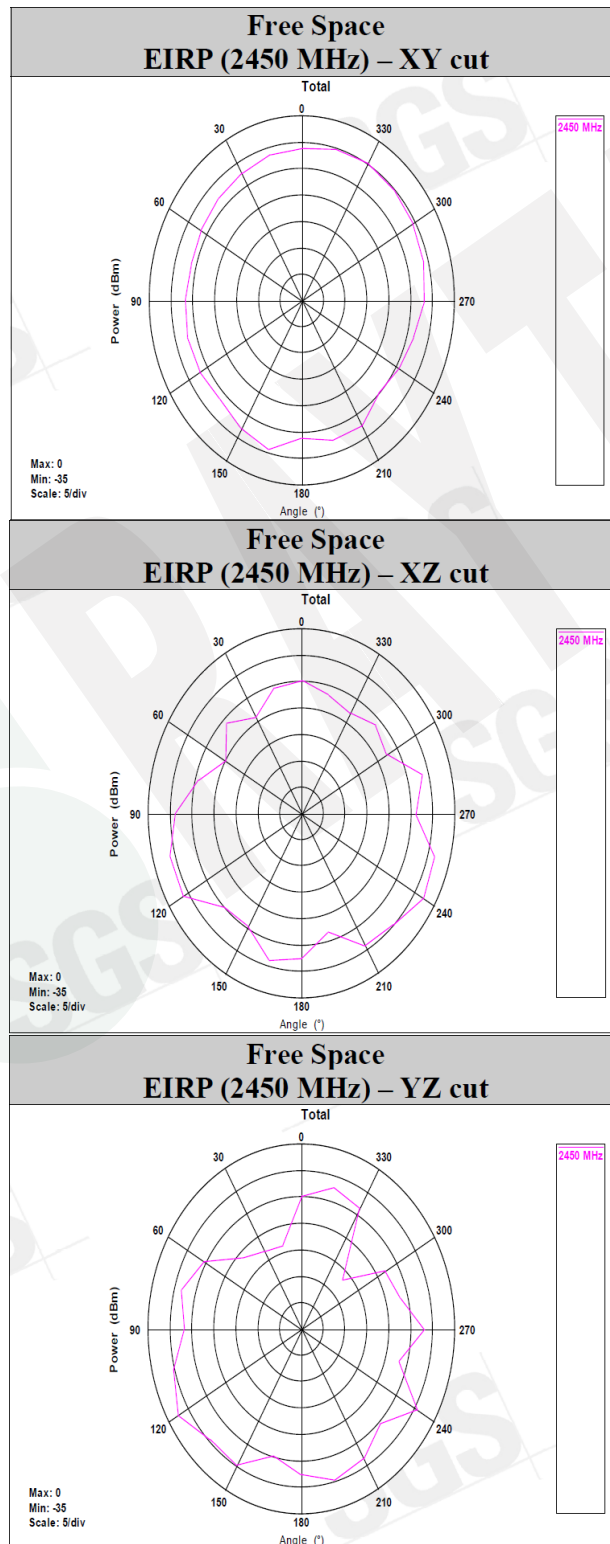

## 7.2. MDBT42T-P

### Test Result

Frequency (MHz)	2400	2410	2420	2430	2440	2450	2460	2470	2480	2490	2500
Gain (dBi)	-4.70	-4.67	-4.70	-5.03	-5.21	-5.45	-5.77	-6.24	-6.72	-7.14	-7.17
Directivity (dBi)	5.25	5.22	5.20	5.12	5.08	4.95	4.82	4.60	4.45	4.35	4.43
Efficiency (dB)	-9.95	-9.89	-9.89	-10.15	-10.29	-10.39	-10.60	-10.84	-11.16	-11.48	-11.60

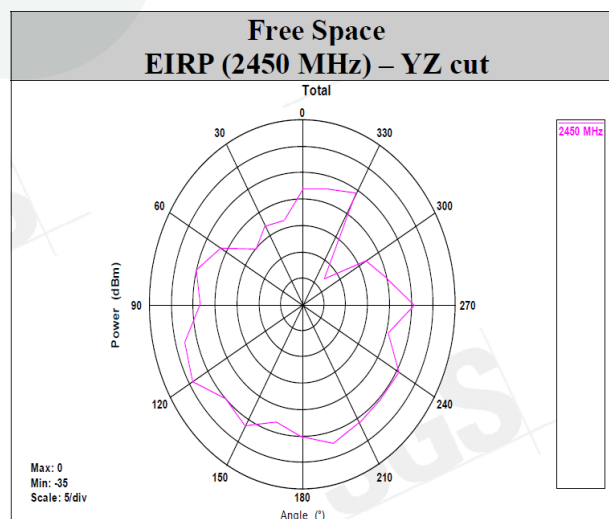
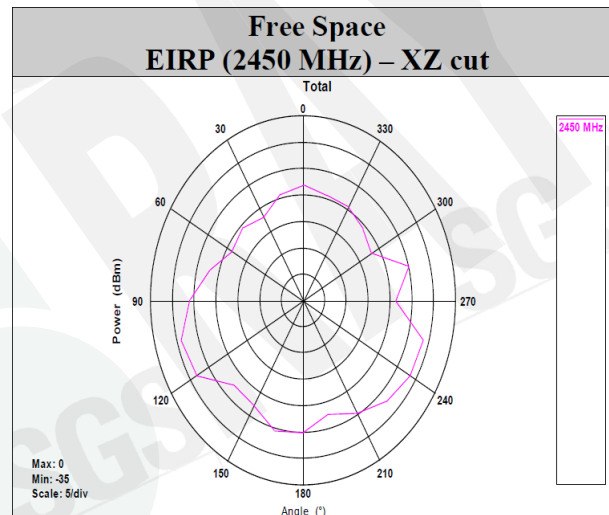
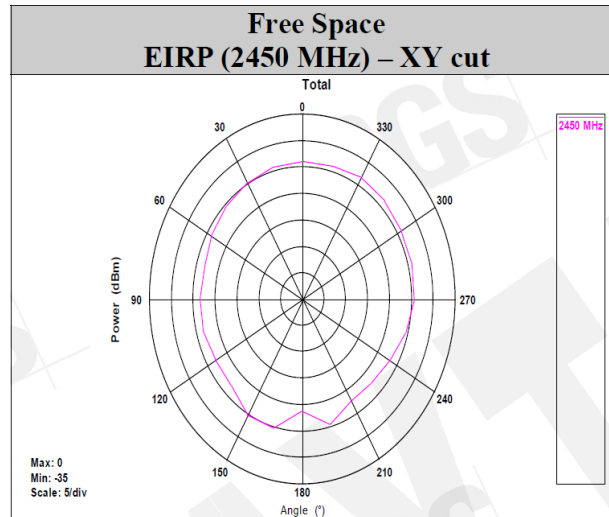

## 8. Reference Circuit

*Module is pre-programmed with Raytac's testing code. Default is using "LDO mode" and needs external 32.768khz to work.*

### REMARK:

**\*\* DEC4 decoupling capacitor (1 $\mu$ F) is already inside the module. \*\***

**\*\* When using DC-DC mode, please add L2 / L3 / C14. \*\***

**\*\* When using internal 32.768khz RC oscillator, please remove X2 / C12 / C13. \*\***

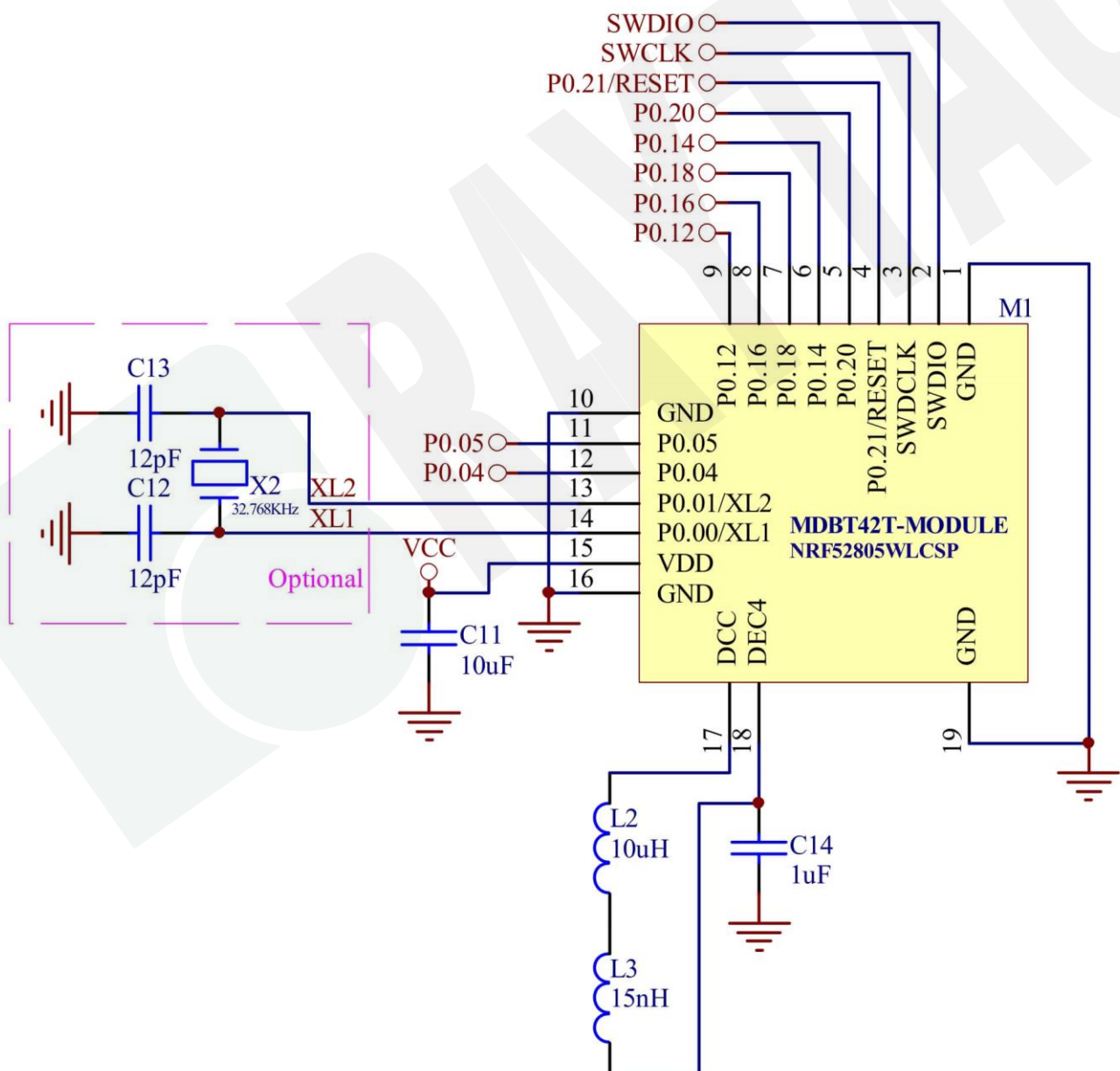

# 9. Certification

## 9.1. Declaration ID

### BT 5.4

Declaration ID	QDID(s)	Company	Specification Name
D066910	232392 - End Product > 228005 - Component (Tested)	Raytac Corporation	5.4

### BT 5.2

Declaration ID	QDID(s)	Company	Specification Name
D053149	159932 - End Product	Raytac Corporation	5.2

### BT 5.1

Declaration ID	QDID(s)	Company	Specification Name
D047708	139361 - End Product	Raytac Corporation	5.1

<b>Profile Description</b>	<b>Service Description</b>
Alert Notification Profile	Alert Notification Service
Blood Pressure Profile	Blood Pressure Service
	Device Information Service
Cycling Speed & Cadence Profile	Cycling Speed & Cadence Service
	Device Information Service
Glucose Profile	Glucose Service
	Device Information Service
Health Thermometer Profile	Health Thermometer Service
	Device Information Service
Heart Rate Profile	Heart Rate Service
	Device Information Service
HID over GATT Profile	HID Service
	Battery Service
Proximity Profile	Link Loss Service
	Immediate Alert Service
	TX Power Service
Running Speed & Cadence Profile	Running Speed & Cadence Service
	Device Information Service
Time Profile	Time Profile Service
Glucose Profile (Central)	
Mesh Profile	Mesh Provisioning Service
	Mesh Proxy Service

## 9.2. FCC Certificate (USA)

### **BLE 1 Mbps & 2 Mbps**

<b>TCB</b>	<b>GRANT OF EQUIPMENT AUTHORIZATION</b>  <b>Certification</b> <b>Issued Under the Authority of the Federal Communications Commission</b>  <b>By:</b>	<b>TCB</b>			
	SGS North America, Inc. 620 Old Peachtree Road NW Suite 100 Suwanee, GA 30024	Date of Grant: 11/16/2020  Application Dated: 11/13/2020			
Raytac Corp. 5F., No.3, Jiankang Rd., Zhonghe Dist., New Taipei City,, 23586 Taiwan					
Attention: Venson Liao , R&D Manager					
<b>NOT TRANSFERABLE</b>					
EQUIPMENT AUTHORIZATION is hereby issued to the named GRANTEE, and is VALID ONLY for the equipment identified hereon for use under the Commission's Rules and Regulations listed below.					
FCC IDENTIFIER: SH6MDBT42T Name of Grantee: Raytac Corp. Equipment Class: Digital Transmission System Notes: BLE Module Modular Type: Single Modular					
<u>Grant Notes</u>	<u>FCC Rule Parts</u>	<u>Frequency Range (MHZ)</u>	<u>Output Watts</u>	<u>Frequency Tolerance</u>	<u>Emission Designator</u>
	15C	2402.0 - 2480.0	0.004		
Single Modular Approval. Output power listed is conducted. Compliance of this device in all final host configurations is the responsibility of the Grantee. OEM integrators and end-users must be provided with specific operating instructions for satisfying RF exposure compliance. OEM integrators are instructed to ensure that the end user has no manual instructions to remove or install the device. This transmitter must not be co-located or operating in conjunction with any other antenna or transmitter except in accordance with FCC multi-transmitter procedures.					

## 9.3. TELEC Certificate (Japan)

### **BLE 1 Mbps & 2 Mbps**

telefication by  
The Netherlands  
Chamber of Commerce  
51565536  
www.telefication.com



**Certificate**  
of  
Radio Equipment in JAPAN  
No: 201-200780 / 00

Telefication, operating as Conformity Assessment Body (CAB ID Number: 201) with respect to Japan, declares that the listed product complies with the Technical Regulations Conformity Certification of Specified Radio equipment (ordinance of MPT N° 37,1981)

Product description: **BLE Module**  
Trademark: **Raytac Corporation**  
Type designation: **MDBT42T**  
Hardware / Software version: **1.0 / 1.0**  
Variants: **See Annex 3**

Manufacturer: **Raytac Corp.**  
Address: **5F., No.3, Jiankang Road, Zhonghe District,  
City: 23586 New Taipei City  
Country: Taiwan**

This certificate is granted to:

Name: **Raytac Corp.**  
Address: **5F., No.3, Jiankang Road, Zhonghe District,  
City: 23586 New Taipei City  
Country: Taiwan**

This certificate has THREE Annexes.

Zevenaar, 21 October 2020

**CAB**

*David Chen*  
David Chen  
Product Assessor



PRODUCTS  
RvA C 224



## 9.4. NCC Certificate (Taiwan)

**BLE 1 Mbps & 2 Mbps**

**MDBT42T**

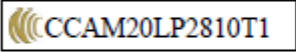
	<b>台灣檢驗科技股份有限公司</b> <b>電信管制射頻器材型式認證證明</b>
證照字號：型式字第 AM 號	
一、申請者：勁達國際電子有限公司	
二、地址：臺北市大安區和平東路1段145號5樓之1	
三、製造廠商：勁達國際電子有限公司	
四、器材名稱：藍牙模組	
五、廠牌：Raytac Corporation	
六、型號：MDBT42T	
七、發射功率(電場強度)：詳細射頻規格如備註欄	
八、工作頻率：詳細射頻規格如備註欄	
九、審驗日期：109年11月12日	
十、審驗合格標籤式樣：	
十一、警語或標示要求：(器材本體、使用手冊、外包裝盒等應遵守下列標示要求)	
1. 應於本體明顯處標示審驗合格標籤或符合性聲明標籤及其型號，並於包裝盒標示主管機關標章。最終產品應於本體明顯處標示非隨插即用射頻模組(組件)之審驗合格標籤及最終產品型號，並於包裝盒標示主管機關標章，始得販賣。	
2. 依主管機關或相關技術規範規定於指定位置標示正體中文警語。	
3. 經授權使用射頻模組(組件)之審驗合格標籤者，應於最終產品說明書及包裝盒提供充分與正確之資訊。	
4. 於網際網路販賣電信管制射頻器材者，應於該網際網路網頁標示其型號及審驗合格標籤或符合性聲明標籤資訊。但最終產品得僅標示其型號及其組裝之非隨插即用射頻模組(組件)之審驗合格標籤資訊。	
5. 使用手冊應標示下列資訊：	
(1) 取得審驗證明之低功率射頻器材，非經核准，公司、商號或使用者均不得擅自變更頻率、加大功率或變更原設計之特性及功能。低功率射頻器材之使用不得影響飛航安全及干擾合法通信；經發現有干擾現象時，應立即停用，並改善至無干擾時方得繼續使用。前述合法通信，指依電信管理法規定作業之無線電通信。低功率射頻器材須忍受合法通信或工業、科學及醫療用電波輻射性電機設備之干擾。	
型式認證號碼：CCAM20LP2810T1	第 1 頁，共 2 頁
本證書與續頁分開使用無效	

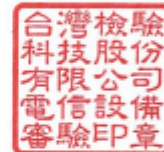

# BLE 1 Mbps & 2 Mbps

## MDBT42T-P



### 台灣檢驗科技股份有限公司 電信管制射頻器材型式認證證明

證照字號：型式字第 AM 號

- 一、申請者：勁達國際電子有限公司
- 二、地址：臺北市大安區和平東路1段145號5樓之1
- 三、製造廠商：勁達國際電子有限公司
- 四、器材名稱：藍牙模組
- 五、廠牌：Raytac Corporation
- 六、型號：MDBT42T-P
- 七、發射功率(電場強度)：詳細射頻規格如備註欄
- 八、工作頻率：詳細射頻規格如備註欄
- 九、審驗日期：109年11月12日

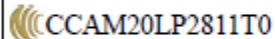
- 十、審驗合格標籤式樣：



- 十一、警語或標示要求：(器材本體、使用手冊、外包裝盒等應遵守下列標示要求)
1. 應於本體明顯處標示審驗合格標籤或符合性聲明標籤及其型號，並於包裝盒標示主管機關印章。最終產品應於本體明顯處標示非隨插即用射頻模組(組件)之審驗合格標籤及最終產品型號，並於包裝盒標示主管機關印章，始得販賣。
  2. 依主管機關或相關技術規範規定於指定位置標示正體中文警語。
  3. 經授權使用射頻模組(組件)之審驗合格標籤者，應於最終產品說明書及包裝盒提供充分與正確之資訊。
  4. 於網際網路販賣電信管制射頻器材者，應於該網際網路網頁標示其型號及審驗合格標籤或符合性聲明標籤資訊。但最終產品僅標示其型號及其組裝之非隨插即用射頻模組(組件)之審驗合格標籤資訊。
  5. 使用手冊應標示下列資訊：
    - (1) 取得審驗證明之低功率射頻器材，非經核准，公司、商號或使用者均不得擅自變更頻率、加大功率或變更原設計之特性及功能。低功率射頻器材之使用不得影響飛航安全及干擾合法通信；經發現有干擾現象時，應立即停用，並改善至無干擾時方得繼續使用。前述合法通信，指依電信管理法規作業之無線電通信。低功率射頻器材須忍受合法通信或工業、科學及醫療用電波輻射性電機設備之干擾。

## 9.5. CE (EU) & RCM (Australia & New Zealand) Test Report

### **BLE 1 Mbps & 2 Mbps**



Page: 4 / 58  
Rev.: 00

Report No.: T200824W09-RT

#### 1. TEST RESULT CERTIFICATION

**Applicant:** Raytac Corp.  
5F.,No.3, Jiankang Road, Zhonghe District, New Taipei City  
23586, Taiwan

**Manufacturer:** Raytac Corp.  
5F.,No.3, Jiankang Road, Zhonghe District, New Taipei City  
23586, Taiwan

**Equipment Under Test:** BLE Module

**Trade Name:** Raytac Corporation

**Model Number:** MDBT42T, MDBT42T-P

**Date of Test:** August 26 ~ September 2, 2020

APPLICABLE STANDARDS	
STANDARD	TEST RESULT
ETSI EN 300 328 V2.2.2: 2019 & AS/NZS 4268:2017	No non-compliance noted
Statements of Conformity	
Determination of compliance is based on the results of the compliance measurement, not taking into account measurement instrumentation uncertainty.	

The above equipment was tested by Compliance Certification Services Inc. for compliance with the requirements set forth in ETSI EN 300 328. The results of testing in this report apply only to the product/system, which was tested. Other similar equipment will not necessarily produce the same results due to production tolerance and measurement uncertainties.

Approved by:

---

Kevin Tsai  
Deputy Manager

## VERIFICATION OF COMPLIANCE

**Issue Date:** Sep. 11, 2020  
**Applicant:** Raytac Corporation  
**Address:** 5F., No.3, Jiankang Road, Zhonghe District, New Taipei City, Taiwan  
**Manufacturer:** Raytac Corporation  
**Address:** 5F., No.3, Jiankang Road, Zhonghe District, New Taipei City 23586, Taiwan

**Contact Information:** Web: www.raytac.com  
TEL#: +886-2-3234-0208  
E-mail#: service@raytac.com

**Product:** BLE Module  
**Brand Name/Trade Mark:** Raytac Corporation  
**Model/Type:** MDBT42T  
**Added Model(s):** MDBT42T-P  
**Applicable Standards:** EN 301 489 -1 v2.2.3 : 2019-11  
EN 301 489 -17 v3.2.2 : 2019-12 (Draft)  
EN 55032 : 2015+AC:2016-07  
EN 61000-4-2 : 2009  
EN 61000-4-3 : 2006+A1:2008+A2:2010

**Test Laboratory:** SGS Taiwan Ltd.  
Electromagnetic Compatibility Laboratory  
No.2, Keji 1st Rd., Guishan District, Taoyuan City, Taiwan

**Test Report No.:** MH/2020/80031, dated on Sep. 11, 2020

**Conclusion:** Based upon a review of the Test Report(s), the tested sample of the product mentioned above is deemed to comply with the requirements of the above standards.

**Note:** This verification is only valid for the product and configuration described and in conjunction with the test report as detailed above.

**Authorised Signatory:**



SGS Taiwan Ltd.  
Eddy Cheng  
Assistant Supervisor



## 9.6. IC Certificate (Canada)

### BLE 1 Mbps & 2 Mbps

SGS

<b>Certificate</b>	US0186.2020.000406
SGS Reference	CCS-CERT201000038-02
<b>Certified Product</b>	BLE Module
ISED ID Number	MDBT42T, MDBT42T-P
Type of Equipment	Bluetooth device
<b>Certificate Holder</b>	Raytac Corp.
Address	5F, No.3, Jiankang Road, New Taipei City 23586 Taiwan

*Certification of equipment means only that the equipment has met the requirements of the above-noted specification. Licence applications, where applicable to use certified equipment, are acted on accordingly by the Industry Canada issuing office and will depend on the existing radio environment, service and location of operation. This certificate is issued on condition that the holder complies and will continue to comply with the requirements and procedures issued by Industry Canada. The equipment for which this certificate is issued shall not be manufactured, imported, distributed, leased, offered for sale or sold unless the equipment complies with the applicable technical specifications and procedures issued by Industry Canada.*

*La certification du matériel signifie seulement que le matériel a satisfait aux exigences de la norme indiquée ci-dessus. Les demandes de licences nécessaires pour l'utilisation du matériel certifié sont traitées en conséquence par le bureau de délivrance d'Industrie Canada et dépendent des conditions radio ambiantes, du service et de l'emplacement d'exploitation. Le présent certificat est délivré à la condition que le titulaire satisfasse et continue de satisfaire aux exigences et aux procédures d'Industrie Canada. Le matériel à l'égard duquel le présent certificat est délivré ne doit pas être fabriqué, importé, distribué, loué, mis en vente ou vendu à moins d'être conforme aux procédures et aux spécifications techniques applicables publiées par Industrie Canada.*

*I hereby attest that the subject equipment was tested and found in compliance with the above-noted specification.*

*J'atteste par la présente que le matériel a fait l'objet d'essai et jugé conforme à la spécification ci-dessus.*

Authorized By	Date Issued
	11/12/2020
Sen. Lv Certifier	US0186

This Certificate is valid only with a concurrent listing with Industry Canada Radio Listing (REL).

SGS North America, Inc.  
620 Old Peachtree Road, Ste. 100, Suwanee, GA 30024, USA  
t +1 770 570 1800 f +1 770 277 1240 www.sgs.com  
Page 1 of 2

EQUIPMENT DETAIL				
Frequency Range (MHz)	RF Power (Watts)	Antenna Type	Necessary Bandwidth(kHz)	Emission Classification
2402.0-2480.0	0.004	Note 1	2014.4	F1D
Notes 1) Chip antenna: -1.52dBi, PCB Antenna: -4.67dBi				
SPECIFICATION				
Standard/Specification	Issue	Issue Date		
RSS-247	Issue 2	February 2017		

Page 2 of 2

## 9.7. SRRC Certificate (China)

**BLE 1 Mbps & 2 Mbps**

**无线电发射设备**  
Radio Transmission Equipment  
**型号核准证**  
Type Approval Certificate

劲达国际电子有限公司 (台湾):

**根据《中华人民共和国无线电管理**  
In accordance with the provisions on the Radio  
**条例》，经审查，下列无线电发射设备**  
Regulations of the People's Republic of China , the following  
**符合中华人民共和国无线电管理规定和**  
radio transmission equipment , after examination , conforms  
**技术标准，其核准代码为：CMIIT ID:2020DJ11286**  
to the provisions with its CMIIT ID:

有效期：五年  
Validity

  
(发证机关)  
Sealed by issuing authority  
2020年09月30日  
Year Month Date

## 9.8. KC Certificate (South Korea)

### **BLE 1 Mbps & 2 Mbps**

88BB-19DC-ABFC-7528

<b>방송통신기자재등의 적합인증서</b> <i>Certificate of Broadcasting and Communication Equipments</i>	
상호 또는 성명 <i>Trade Name or Applicant</i>	Raytac Corporation
기자재명칭(명칭) <i>Equipment Name</i>	특정소출력 무선기기(무선데이터통신시스템용 무선기기)
기본모델명 <i>Basic Model Number</i>	MDBT42T
파생모델명 <i>Series Model Number</i>	MDBT42T-P
인증번호 <i>Certification No.</i>	R-C-ryt-MDBT42T
제조사/제조국가 <i>Manufacturer/ Country of Origin</i>	Raytac Corporation / 대만
인증연월일 <i>Date of Certification</i>	2020-09-14
기타 <i>Others</i>	
<p>위 기자재는 「전파법」 제58조의2 제2항에 따라 인증되었음을 증명합니다.                      It is verified that foregoing equipment has been certificated under the Clause 2, Article 58-2 of Radio Waves Act.</p> <p style="text-align: right;">2020년(Year) 09월(Month) 14일(Day)</p> <p style="text-align: center;">국립전파연구원장 </p> <p style="text-align: center;"><i>Director General of National Radio Research Agency</i></p> <p style="text-align: center; font-size: small;">※ 인증 받은 방송통신기자재는 반드시 "적합성평가표시" 를 부착하여 유통하여야 합니다.                      위반시 과태료 처분 및 인증이 취소될 수 있습니다.</p>	

## 9.9. RoHS & REACH Report

Please visit "[Support](#)" page of our website to download.

## 9.10. End-Product Label

It is suggested using following content adding to package or user manual or label to obey the regulation. Any rules of end-product label shall refer to each regulation for final reference.

### 9.10.1. FCC (USA)

The FCC statement should be included in the user manual when there is no enough space on label. Otherwise, it should be included on the label.

"This device complies with part 15 of the FCC rules. Operation is subject to the following two conditions. (1) This device may not cause harmful interference. (2) This device must accept any interference received, including interference that may cause undesired operation."

The final end product must be labeled in a visible area with the following: "Contain FCC ID: SH6MDBT42T".

### 9.10.2. TELEC (Japan)

When manufacturer is placing the product on the Japanese market, the product must be affixed with the following Specified Radio Equipment marking:





### 9.10.3. NCC (Taiwan)

請依下列標籤式樣自製標籤，標貼或印鑄於器材本體明顯處，始得販賣或公開陳列。

#### MDBT42T Series

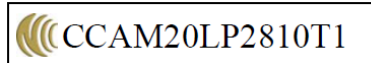

#### MDBT42T-P Series

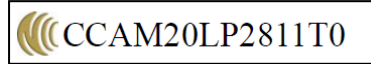

平台廠商必須於平台上標示字樣「本產品內含射頻模組：ID 編號 CCAM20LP2810T1」或「本產品內含射頻模組：ID 編號 CCAM20LP2811T0」。

「平台」定義如下：若器材組裝本案模組，消費者仍能正常使用該器材主要功能，該器材得視為平台。若器材不組裝本案模組，消費者不能正常使用該器材主要功能，該器材不能視為平台。該類不同廠牌型號器材組裝本案審驗模組後，須分別申請型式認證。

### 9.10.4. IC (Canada)

The IC statement should be included in the user manual when there is no enough space on label. Otherwise, it should be included on the label.

“This device complies with Industry Canada license-exempt RSS Standard(s). Operation is subject to the following two conditions. (1) This device may not cause harmful interference. (2) This device must accept any interference received, including interference that may cause undesired operation.

Le présent appareil est conforme aux CNR d'Industrie Canada applicables aux appareils radio exempts de licence. L'exploitation est autorisée aux deux conditions suivantes: (1) l'appareil ne doit pas produire de brouillage, et (2) l'utilisateur de l'appareil doit accepter tout brouillage radioélectrique subi, même si le brouillage est susceptible d'en compromettre le fonctionnement.”

The final end product must be labeled in a visible area with the following: “Contain IC ID: 8017A-MDBT42T”.

## 10. Notes and Cautions

Module is not designed to last for a lifetime. Like general products, it is expected to be worn out after continuous usage through the years. To assure that product will perform better and last longer, please make sure you:

- Follow the guidelines of this document while designing circuit/end-product. Any discrepancy of core Bluetooth technology and technical specification of IC should refer to definition of Bluetooth Organization and Nordic Semiconductor as final reference.
- Do not supply voltage that is not within range of specification.
- Eliminate static electricity at any cost when working with the module as it may cause damage. It is highly recommended adding anti-ESD components to circuit design to prevent damage from real-life ESD events. Anti-ESD methods can be also applied in mechanical design.
- Do not expose modules under direct sunlight for long duration. Modules should be kept away from humid and salty air conditions, and any corrosive gasses or substances. Store it within  $-40^{\circ}\text{C}$  to  $+125^{\circ}\text{C}$  before and after installation.
- Avoid any physical shock, intense stress to the module or its surface.
- Do not wash the module. No-Clean Paste is used in production. Washing it will oxidize the metal shield and have chemistry reaction with No-Clean Paste. Functions of the module are not guaranteed if it has been washed.

The module is not suitable for life support device or system and not allowed to be used in destructive device or systems in any direct or indirect ways. The customer agrees to indemnify Raytac for any losses when applying modules in applications such as the ones described above.

# 11. Basic Facts for nRF52 Chip

Below chart shows basic spec for Nordic nRF52 family, which is helpful to understand the differences between each SoC. Any discrepancy shall refer to Nordic’s technical document as final reference.

See [Full List of Raytac’s BLE Modules](#) for complete model no. of each item.

Nordic Solution	nRF52840	nRF52833	nRF52820	nRF52832	nRF52810	nRF52811	nRF52805
RAYTAC Model No. (MDBTXX)	50Q series	50Q series 50 series	50 series	42Q series 42 series 42V series	42Q series	42Q Series	42T series 42TV series
Bluetooth Direction Finding		V	V			V	
Bluetooth 5 Long Range (125kbps)	V	V	V			V	
Bluetooth 5 High Speed	V	V	V	V	V	V	V
Bluetooth 5 Ad. Extention (x8)	V	V	V	V	V	V	V
Flash (kBytes)	1024	512	256	512	192	192	192
RAM (kBytes)	256	128	32	64	24	24	24
ANT Plus	V	V	V	V	V	V	
IEEE 802.15.4	V	V	V			V	
ARM® TrustZone® Cryptocell	V						
USB	V	V	V				
QSPI	V						
NFC	V	V		V			
I2S	V	V		V			
SPI, TWI, UART, PWM	V	V	V	V	V	V	without PWM
PDM	V	V		V	V	V	
ADC, Comparators	V	V	without ADC	V	V	V	without comparators
Supply Range (V)	1.7 to 5.5	1.7 to 5.5	1.7 to 5.5	1.7 to 3.6	1.7 to 3.6	1.7 to 3.6	1.7 to 3.6

## 12. Useful Links

- **Nordic Infocenter:** <https://infocenter.nordicsemi.com/index.jsp>  
All the necessary technical files of Nordic's chip are on this website.
- **Nordic DevZone:** <https://devzone.nordicsemi.com/questions/>  
A highly recommended website for firmware developer. Interact with other developers and Nordic's employees will help with your questions. The site also includes tutorials in detail to help you get started.
- **Official Page of nRF52805 :**  
<https://www.nordicsemi.com/Products/Low-power-short-range-wireless/nRF52805>  
A brief introduction to nRF52805 and download links for Nordic's developing software and SoftDevices.

# Full List of Raytac's BLE Modules

## ● MDBT40 Series

Series	Nordic Solution	Raytac No.	IC Ver.	Antenna	RAM	Flash Memory
MDBT40	nRF51822	MDBT40-256V3	3	Chip Antenna	16 kb	256 K
		MDBT40-256RV3			32 kb	256 K
MDBT40-P	nRF51822	MDBT40-P256V3	3	PCB Antenna	16 kb	256 K
		MDBT40-P256RV3			32 kb	256 K

## ● MDBT42Q Series (QFN Package IC)

Series	Nordic Solution	Raytac No.	IC Ver.	Antenna	RAM	Flash Memory
MDBT42Q	nRF52832	MDBT42Q-512KEN	3	Chip Antenna	64 kb	512 K
	nRF52832	MDBT42Q-512KV2	2			
	nRF52810	MDBT42Q-192KV2	2		24 kb	192 K
	nRF52811	MDBT42Q-192KL	1			
MDBT42Q-P	nRF52832	MDBT42Q-P512KEN	3	PCB Antenna	64 kb	512 K
	nRF52832	MDBT42Q-P512KV2	2			
	nRF52810	MDBT42Q-P192KV2	2		24 kb	192 K
	nRF52811	MDBT42Q-P192KL	1			
MDBT42Q-U	nRF52832	MDBT42Q-U512KEN	3	u.FL Connector	64 kb	512 K
	nRF52832	MDBT42Q-U512KV2	2			

## ● MDBT42 Series (WLCSP Package IC)

Series	Nordic Solution	Raytac No.	IC Ver.	Antenna	RAM	Flash Memory
MDBT42	nRF52832	MDBT42-512KV2	2	Chip Antenna	64 kb	512 K
MDBT42-P		MDBT42-P512KV2		PCB Antenna		

## ● MDBT42V Series (WLCSP Package IC)

Series	Nordic Solution	Raytac No.	IC Ver.	Antenna	RAM	Flash Memory
MDBT42V	nRF52832	MDBT42V-512KV2	2	Chip Antenna	64 kb	512 K
MDBT42V-P		MDBT42V-P512KV2		PCB Antenna		

## ● MDBT42T Series (WLCSP Package IC)

Series	Nordic Solution	Raytac No.	IC Ver.	Antenna	RAM	Flash Memory
MDBT42T	nRF52805	MDBT42T-192K	1	Chip Antenna	24 kb	192 K
MDBT42T-P		MDBT42T-P192K		PCB Antenna		

## ● MDBT42TV Series (WLCSP Package IC)

Series	Nordic Solution	Raytac No.	IC Ver.	Antenna	RAM	Flash Memory
MDBT42TV	nRF52805	MDBT42TV-192K	1	Chip Antenna	24 kb	192 K
MDBT42TV-P		MDBT42TV-P192K		PCB Antenna		

## ● MDBT50Q Series (aQFN Package IC)

Series	Nordic Solution	Raytac No.	IC Ver.	Antenna	RAM	Flash Memory
MDBT50Q	nRF52840	MDBT50Q-1MEN	3	Chip Antenna	256 kb	1 MB
	nRF52840	MDBT50Q-1MV2	2			
	nRF52833	MDBT50Q-512K	1		128 kb	512 kb
MDBT50Q-P	nRF52840	MDBT50Q-P1MEN	3	PCB Antenna	256 kb	1 MB
	nRF52840	MDBT50Q-P1MV2	2			
	nRF52833	MDBT50Q-P512K	1		128 kb	512 kb
MDBT50Q-U	nRF52840	MDBT50Q-U1MEN	3	u.FL Connector	256 kb	1 MB
	nRF52840	MDBT50Q-U1MV2	2			
	nRF52833	MDBT50Q-U512K	1		128 kb	512 kb
Dongle	nRF52840	MDBT50Q-RX	1, 2	PCB Antenna	256 kb	1 MB

## ● MDBT50 Series (QFN Package IC)

Series	Nordic Solution	Raytac No.	IC Ver.	Antenna	RAM	Flash Memory
MDBT50	nRF52820	MDBT50-256R	1	Chip Antenna	32 kb	256 kb
	nRF52833	MDBT50-512K	1		128 kb	512 kb
MDBT50-P	nRF52820	MDBT50-P256R	1	PCB Antenna	32 kb	256 kb
	nRF52833	MDBT50-P512K	1		128 kb	512 kb

## ● MDBT53 Series (WLCSP Package IC)

Series	Nordic Solution	Raytac No.	IC Ver.	Antenna	RAM	Flash Memory
MDBT53	nRF5340	MDBT53-1M	1	Chip Antenna	512 kb	1 MB
MDBT53-P	nRF5340	MDBT53-P1M	1	PCB Antenna	512 kb	1 MB
MDBT53-U	nRF5340	MDBT53-U1M	1	u.FL Connector	512 kb	1 MB

## ● MDBT53V Series (WLCSP Package IC)

Series	Nordic Solution	Raytac No.	IC Ver.	Antenna	RAM	Flash Memory
MDBT53V	nRF5340	MDBT53V-1M	1	Chip Antenna	512 kb	1 MB
MDBT53V-P	nRF5340	MDBT53V-P1M	1	PCB Antenna	512 kb	1 MB



# Release Note

- 2020/07/02 Version A: 1<sup>st</sup> release
- 2020/11/20 Version B
  - (1) Updated photos of the module, weight info, contexts of the shield and tray info in Chapter 4: Shipment Packaging Information.
  - (2) Updated technical info based on nRF52805 Product Specification v1.2 in Chapter 5: Specification.
  - (3) Added Chapter 7: Antenna & Chapter 9: Certification.
  - (4) Corrected the usage of DC-DC mode in Chapter 8: Reference Circuit.
  - (5) Updated table in Chapter 11: Basic Facts for nRF52 Chip.
- 2023/08/01 Version C
  - (1) Updated drawing in Chapter 2 for a better understanding of PCB measurement & RF Layout Suggestion.
  - (2) Updated Full List of Raytac's BLE modules.
  - (3) Updated Chapter 5: Specification corresponding to Nordic's new nRF52805 Product Specification V1.3.
- 2023/12/01 Version D
  - (1) Added packaging info and order code in Chapter 4.
  - (2) Updated Chapter 2: 2.3 RF Layout Suggestion (aka Keep-Out Area).
- 2024/02/29 Version E
  - (1) Updated Chapter 5: Specification corresponding to Nordic's new nRF52805 Product Specification V1.4.
  - (2) Updated declaration ID in Chapter 9.
  - (3) Updated list of Raytac's BLE modules.