

**Silicon Carbide (SiC)
 Schottky Diode – EliteSiC,
 40 A, 1200 V, D3, TO-247-2L**

NDSH40120C-F155

Description

Silicon Carbide (SiC) Schottky Diodes use a completely new technology that provides superior switching performance and higher reliability compared to Silicon. No reverse recovery current, temperature independent switching characteristics, and excellent thermal performance sets Silicon Carbide as the next generation of power semiconductor. System benefits include highest efficiency, faster operating frequency, increased power density, reduced EMI, and reduced system size and cost.

Features

- Max Junction Temperature 175°C
- Avalanche Rated 251 mJ
- High Surge Current Capacity
- Positive Temperature Coefficient
- Ease of Paralleling
- No Reverse Recovery / No Forward Recovery
- These Devices are Halogen Free/BFR Free and are RoHS Compliant

Applications

- General Purpose
- SMPS, Solar Inverter, UPS
- Power Switching Circuits

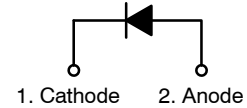

Schottky Diode

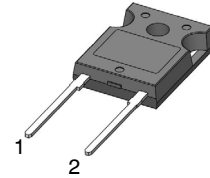

TO-247-2LD
 CASE 340DC

MARKING DIAGRAM

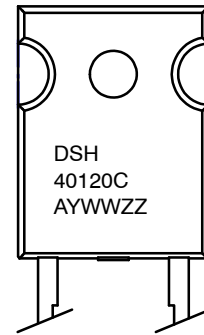

DSH40120C	= Specific Device Code
A	= Assembly Plant Code
YWW	= Date Code (Year & Week)
ZZ	= Lot Code

ORDERING INFORMATION

See detailed ordering and shipping information on page 2 of this data sheet.

NDSH40120C–F155

ABSOLUTE MAXIMUM RATINGS (T_J = 25°C unless otherwise noted)

Symbol	Parameter	Value	Unit	
V _{RRM}	Peak Repetitive Reverse Voltage	1200	V	
E _{AS}	Single Pulse Avalanche Energy (Note 1)	251	mJ	
I _F	Continuous Rectified Forward Current @ T _C < 143°C	40	A	
	Continuous Rectified Forward Current @ T _C < 135°C	46		
I _{F, Max}	Non-Repetitive Peak Forward Surge Current	T _C = 25°C, 10 μs	1295	A
		T _C = 150°C, 10 μs	1274	A
I _{F, SM}	Non-Repetitive Forward Surge Current	Half-Sine Pulse, t _p = 8.3 ms	195	A
I _{F, RM}	Repetitive Forward Surge Current	Half-Sine Pulse, t _p = 8.3 ms	73	A
P _{tot}	Power Dissipation	T _C = 25°C	366	W
		T _C = 150°C	61	W
T _J , T _{STG}	Operating and Storage Temperature Range	-55 to +175	°C	

Stresses exceeding those listed in the Maximum Ratings table may damage the device. If any of these limits are exceeded, device functionality should not be assumed, damage may occur and reliability may be affected.

1. E_{AS} of 251 mJ is based on starting T_J = 25°C, L = 0.5 mH, I_{AS} = 31.7 A, V = 50 V.

THERMAL CHARACTERISTICS

Symbol	Parameter	Value	Unit
R _{θJC}	Thermal Resistance, Junction to Case, Max	0.41	°C/W
R _{θJA}	Thermal Resistance, Junction to Ambient, Max	40	°C/W

ELECTRICAL CHARACTERISTICS (T_J = 25°C unless otherwise noted)

Symbol	Parameter	Test Condition	Min	Typ	Max	Unit
V _F	Forward Voltage	I _F = 40 A, T _J = 25°C	-	1.4	1.75	V
		I _F = 40 A, T _J = 125°C	-	1.66	-	
		I _F = 40 A, T _J = 175°C	-	1.9	-	
I _R	Reverse Current	V _R = 1200 V, T _J = 25°C	-	9	200	μA
		V _R = 1200 V, T _J = 125°C	-	22	200	
		V _R = 1200 V, T _J = 175°C	-	46	200	
Q _C	Total Capacitive Charge	V = 800 V	-	184	-	nC
C	Total Capacitance	V _R = 1 V, f = 100 kHz	-	2840	-	pF
		V _R = 400 V, f = 100 kHz	-	159	-	
		V _R = 800 V, f = 100 kHz	-	115	-	

Product parametric performance is indicated in the Electrical Characteristics for the listed test conditions, unless otherwise noted. Product performance may not be indicated by the Electrical Characteristics if operated under different conditions.

ORDERING INFORMATION

Part Number	Top Marking	Package	Shipping
NDSH40120C–F155	DSH40120C	TO-247–2LD (Pb-Free / Halogen Free)	30 Units / Tube

NDSH40120C-F155

TYPICAL CHARACTERISTICS ($T_J = 25^\circ\text{C}$ unless otherwise noted)

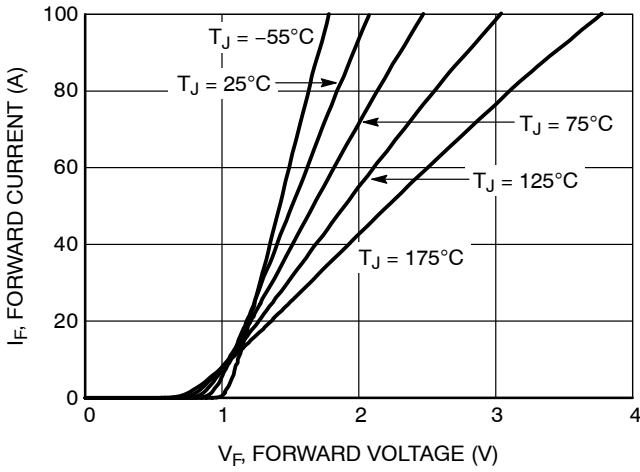

Figure 1. Forward Characteristics

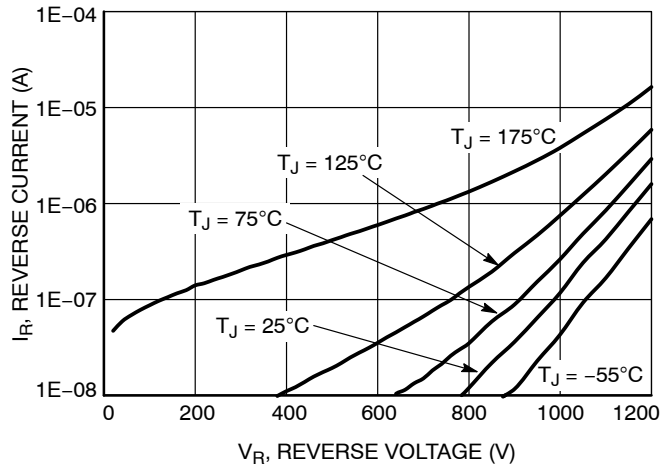

Figure 2. Reverse Characteristics

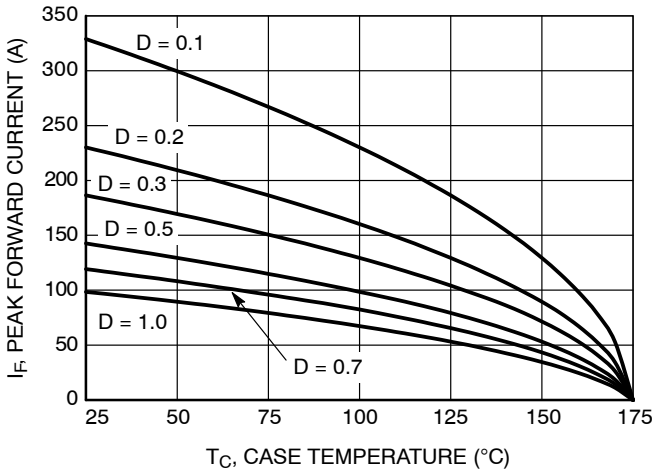

Figure 3. Current Derating

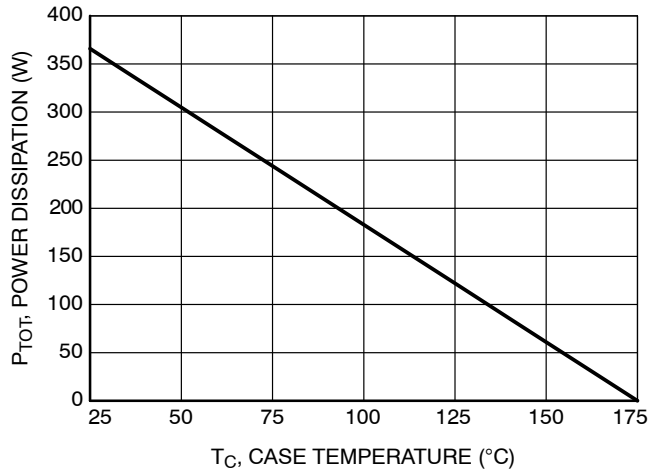

Figure 4. Power Derating

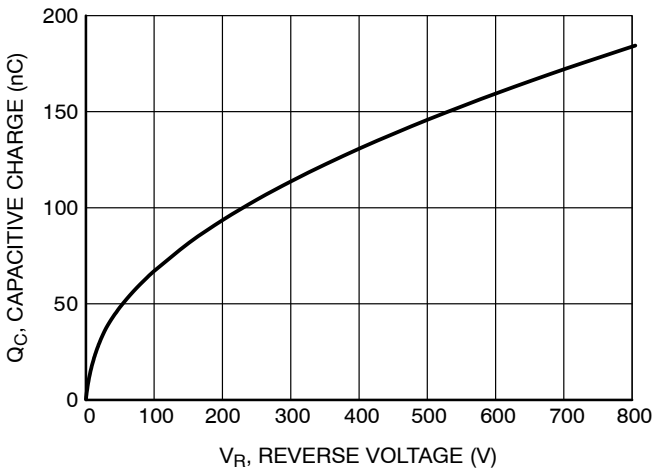

Figure 5. Capacitive Charge vs. Reverse Voltage

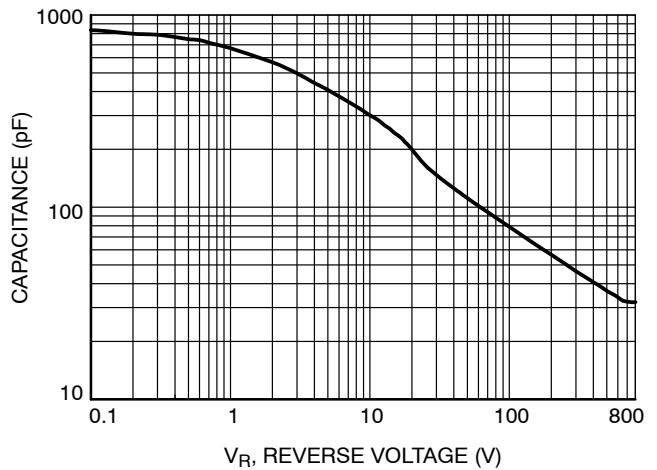

Figure 6. Capacitive vs. Reverse Voltage

NDSH40120C-F155

TYPICAL CHARACTERISTICS ($T_J = 25^\circ\text{C}$ unless otherwise noted)

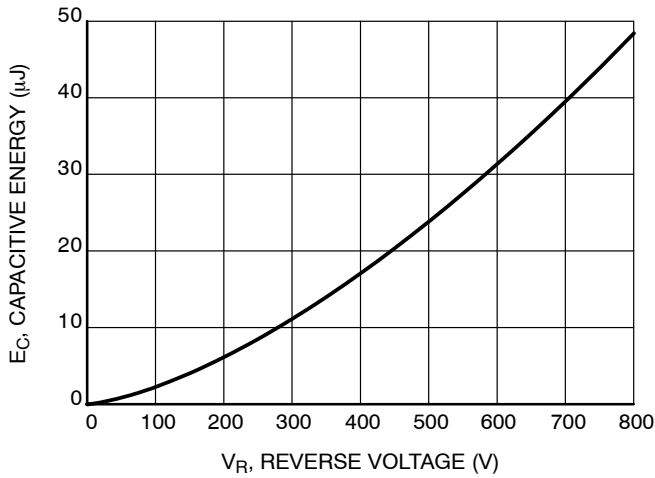

Figure 7. Capacitance Stored Energy

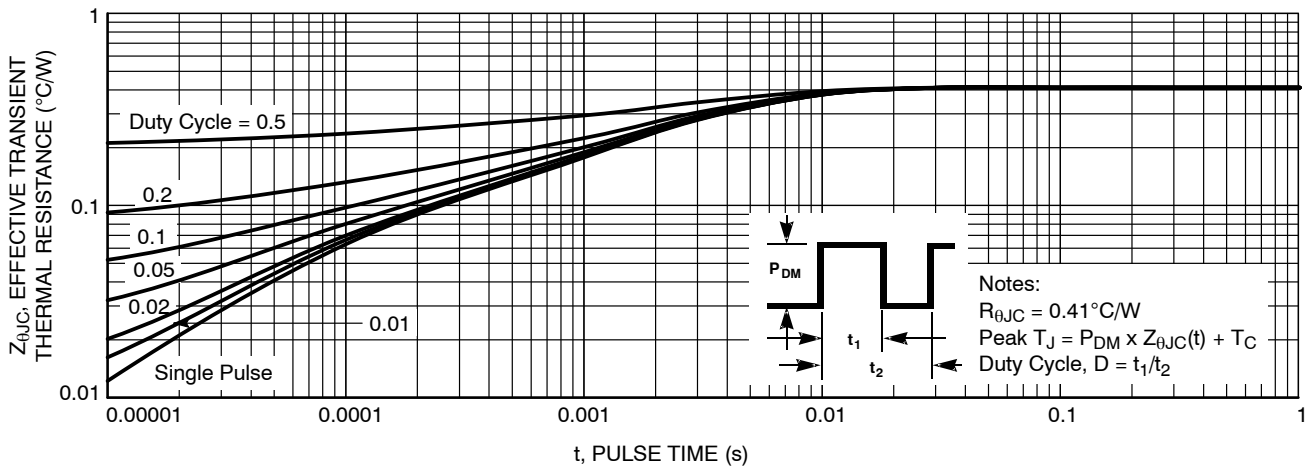
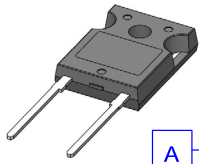

Figure 8. Junction-to-Case Transient Thermal Response Curve

MECHANICAL CASE OUTLINE

PACKAGE DIMENSIONS

ON Semiconductor®



TO-247-2LD
CASE 340DC
ISSUE O

DATE 09 JUL 2020

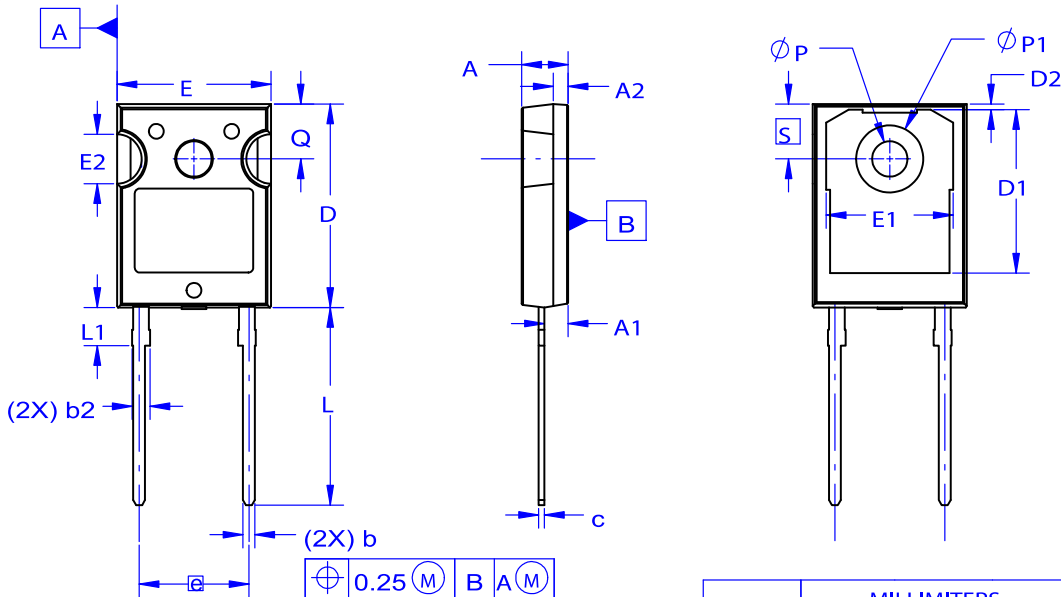

NOTES:

- A. DIMENSIONS ARE EXCLUSIVE OF BURRS, MOLD FLASH AND TIE BAR PROTRUSIONS.
- B. ALL DIMENSIONS ARE IN MILLIMETERS.
- C. DIMENSION AND TOLERANCE AS PER ASME Y14.5-2009.
- D. DIMENSION A1 TO BE MEASURED IN THE REGION DEFINED BY L1.
- E. LEAD FINISH IS UNCONTROLLED IN THE REGION DEFINED BY L1.

DIM	MILLIMETERS		
	MIN	NOM	MAX
A	4.58	4.70	4.82
A1	2.20	2.40	2.60
A2	1.40	1.50	1.60
b	1.17	1.26	1.35
b2	1.60	1.72	1.84
c	0.51	0.61	0.71
D	20.32	20.57	20.82
D1	13.08	~	~
D2	0.51	0.93	1.35
E	15.37	15.62	15.87
E1	12.81	~	~
E2	4.96	5.08	5.20
e	~	11.12	~
L	19.75	20.00	20.25
L1	3.69	3.81	3.93
ϕ P	3.51	3.58	3.65
ϕ P1	6.60	6.80	7.00
Q	5.34	5.46	5.58
S	5.34	5.46	5.58

GENERIC MARKING DIAGRAM*

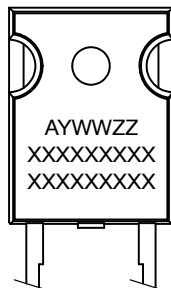

- XXXXX = Specific Device Code
- A = Assembly Location
- Y = Year
- WW = Work Week
- ZZ = Assembly Lot Code

*This information is generic. Please refer to device data sheet for actual part marking. Pb-Free indicator, "G" or microdot "•", may or may not be present. Some products may not follow the Generic Marking.

DOCUMENT NUMBER:	98AON15748H	Electronic versions are uncontrolled except when accessed directly from the Document Repository. Printed versions are uncontrolled except when stamped "CONTROLLED COPY" in red.
DESCRIPTION:	TO-247-2LD	PAGE 1 OF 1

ON Semiconductor and are trademarks of Semiconductor Components Industries, LLC dba ON Semiconductor or its subsidiaries in the United States and/or other countries. ON Semiconductor reserves the right to make changes without further notice to any products herein. ON Semiconductor makes no warranty, representation or guarantee regarding the suitability of its products for any particular purpose, nor does ON Semiconductor assume any liability arising out of the application or use of any product or circuit, and specifically disclaims any and all liability, including without limitation special, consequential or incidental damages. ON Semiconductor does not convey any license under its patent rights nor the rights of others.

onsemi, **Onsemi**, and other names, marks, and brands are registered and/or common law trademarks of Semiconductor Components Industries, LLC dba "**onsemi**" or its affiliates and/or subsidiaries in the United States and/or other countries. **onsemi** owns the rights to a number of patents, trademarks, copyrights, trade secrets, and other intellectual property. A listing of **onsemi**'s product/patent coverage may be accessed at www.onsemi.com/site/pdf/Patent-Marking.pdf. **onsemi** reserves the right to make changes at any time to any products or information herein, without notice. The information herein is provided "as-is" and **onsemi** makes no warranty, representation or guarantee regarding the accuracy of the information, product features, availability, functionality, or suitability of its products for any particular purpose, nor does **onsemi** assume any liability arising out of the application or use of any product or circuit, and specifically disclaims any and all liability, including without limitation special, consequential or incidental damages. Buyer is responsible for its products and applications using **onsemi** products, including compliance with all laws, regulations and safety requirements or standards, regardless of any support or applications information provided by **onsemi**. "Typical" parameters which may be provided in **onsemi** data sheets and/or specifications can and do vary in different applications and actual performance may vary over time. All operating parameters, including "Typicals" must be validated for each customer application by customer's technical experts. **onsemi** does not convey any license under any of its intellectual property rights nor the rights of others. **onsemi** products are not designed, intended, or authorized for use as a critical component in life support systems or any FDA Class 3 medical devices or medical devices with a same or similar classification in a foreign jurisdiction or any devices intended for implantation in the human body. Should Buyer purchase or use **onsemi** products for any such unintended or unauthorized application, Buyer shall indemnify and hold **onsemi** and its officers, employees, subsidiaries, affiliates, and distributors harmless against all claims, costs, damages, and expenses, and reasonable attorney fees arising out of, directly or indirectly, any claim of personal injury or death associated with such unintended or unauthorized use, even if such claim alleges that **onsemi** was negligent regarding the design or manufacture of the part. **onsemi** is an Equal Opportunity/Affirmative Action Employer. This literature is subject to all applicable copyright laws and is not for resale in any manner.

ADDITIONAL INFORMATION

TECHNICAL PUBLICATIONS:

Technical Library: www.onsemi.com/design/resources/technical-documentation
onsemi Website: www.onsemi.com

ONLINE SUPPORT: www.onsemi.com/support

For additional information, please contact your local Sales Representative at www.onsemi.com/support/sales