

High power series connector (45A series)



PSL200 Series

PSL200 is a plastic high current connector used for the connection between battery packs for the applications in BMS and energy storage.

Technical Data

Current Rating	200A
Voltage Rating	1500V AC
Dielectric Withstanding Voltage	3000V AC
Operating Temperature Range	-40 °C to +125 °C
Mating Cycles	500 times Min.
Connector Type	Plug
Part Number	PCNBC005RC78-0

Product Features

Automatic Secondary Lock	YES
--------------------------	-----

Application

Energy Storage System
High Power Application

PSL200

Plug Interface Dimensions

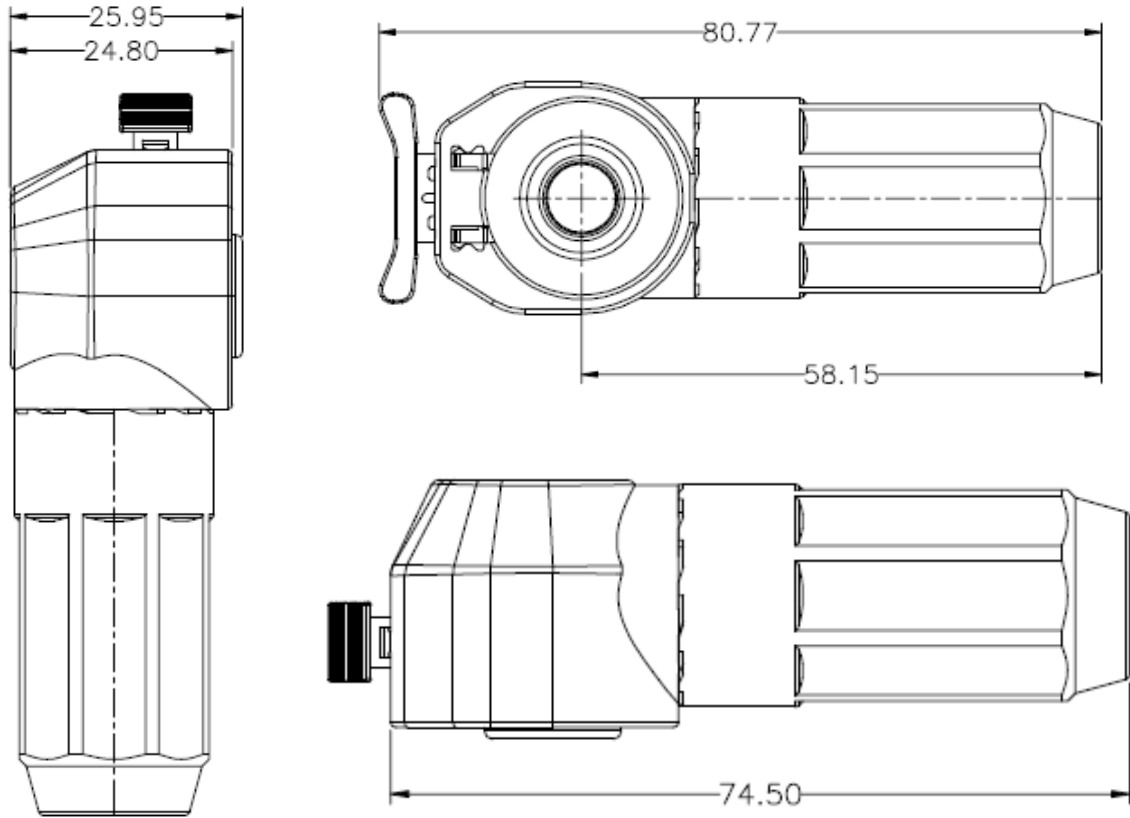

Product Profile

